

SHAD

SUZUKI SV 650 '16
SOSV65iF

3P
SYSTEM

DESIGNED IN
BARCELONA

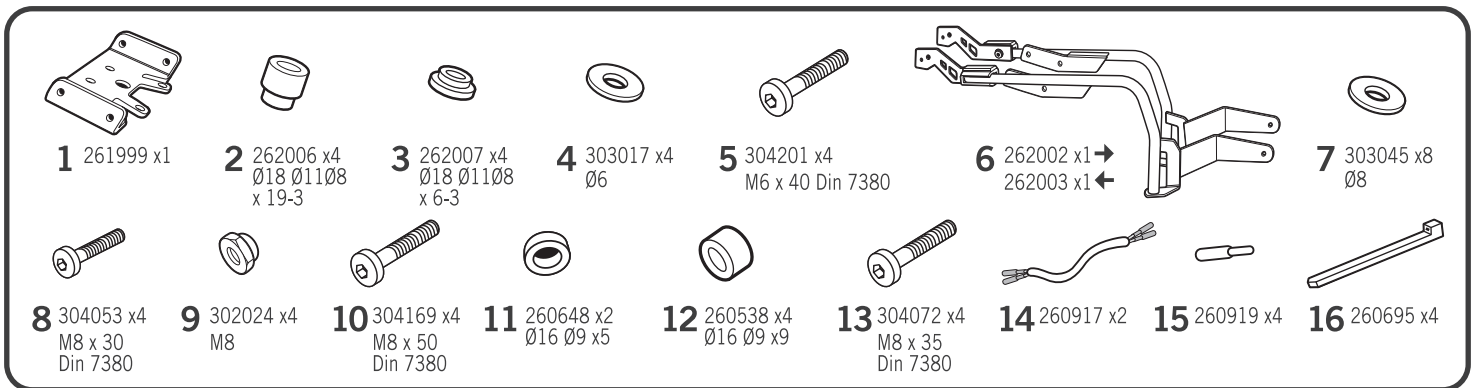

! WARNING!

GB Do not fully tighten the screws until it is ensured that the KIT is correctly attached and aligned.

E No apretar los tornillos del todo hasta asegurarse que el KIT está correctamente colocado y alineado.

D Ziehen Sie die Schrauben nicht ganz fest, bevor Sie sich nicht vergewissert haben, daß der Bausatz korrekt eingestellt und ausgerichtet ist.

I Non stringere del tutto le viti fin tanto non si è sicuri che il kit è collocato correttamente e allineato.

F Ne pas serrer les vis avant d'être sûr que le KIT est correctement monté et ajusté.

ATTENTION: For a full equip assembly, mount the 3p system after the top master.

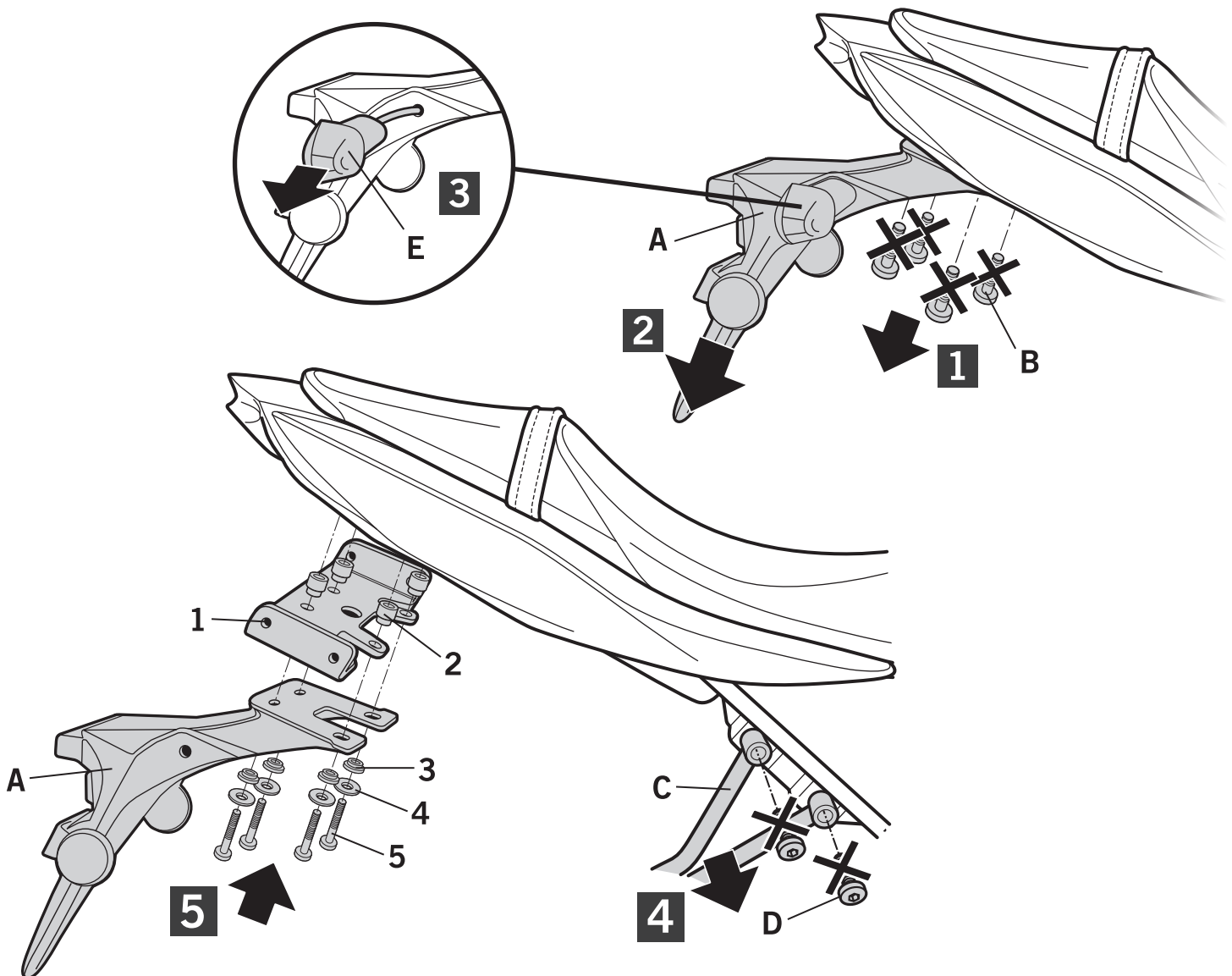

IMPORTANT: Based on European models. For compatibility with models in other continents, check www.shad.es

