

RP7407 - RP7407

PARACOPPA - OIL CARTER PROTECTOR - SABOT MOTEUR - SPEZIFISCHER MOTORSCHUTZ - CUBRE CARTER - CARTER COBRE

DUCATI SCRAMBLER 800 (2015)

N°	Descrizione	Caratteristiche	Codice	Quantità
1	Paracoppa - Oil Carter Protector - Sabot Moteur Spezifischer Motorschutz - Cubre Carter - Carter Cobre		RP7407	1
2	Supporto - Support - Support Halterung - Soporte - Apoio	-	GL2988	1
3	Supporto - Support - Support Halterung - Soporte - Apoio	-	GL2990	1
4	Supporto - Support - Support Halterung - Soporte - Apoio	-	GL2987	1
5	Supporto - Support - Support Halterung - Soporte - Apoio	-	GL2989	1
6	Vite - Screw Vis - Schraube Tornillo - Parafuso	TBEI M8x35	835TBEI	2
7	Vite - Screw Vis - Schraube Tornillo - Parafuso	TBEI M6x50	650TBEI	1
8	Vite - Screw Vis - Schraube Tornillo - Parafuso	TBEIFN M6x16	616TBEIFN	4
9	Vite - Screw Vis - Schraube Tornillo - Parafuso	TCE M10x35	1035TCE	1
10	Distanziale - Spacer Entretoise - Distanzstueck Distanciador - Espaçador	Ø16x40 foro 8.5mm	C16L40F8,5	2
11	Distanziale - Spacer Entretoise - Distanzstueck Distanciador - Espaçador	Ø16x14 foro 8.5mm	C16L14F8,5	2
12	Distanziale - Spacer Entretoise - Distanzstueck Distanciador - Espaçador	Ø16x10 foro 10.2mm	C16L10F10,2	1
13	Fisher - Expanding Tube Insert Cheville - Elastischer Rohreinsatz Taco	-	V695	2
14	Cono Filettato - Threaded Cone Cone Filete - Kegel Gewinde Cono Roscado		V697	2

RP7407 - RP7407

PARACOPPA - OIL CARTER PROTECTOR - SABOT MOTEUR - SPEZIFISCHER MOTORSCHUTZ - CUBRE CARTER - CARTER COBRE

DUCATI SCRAMBLER 800 (2015)

N°	Descrizione	Caratteristiche	Codice	Quantità
15	Rondella - Washer Rondelle - Scheibe Arandela	INOX	805RONX	4
16	Rondella - Washer Rondelle - Scheibe Arandela	Ø6	6RON	1
17	Rondella - Washer Rondelle - Scheibe Arandela	Rondella in Nylon	Z1979	4
18	Rondella - Washer Rondelle - Scheibe Arandela	-	101RON	1
19	Dado - Bolt - Ecrou Mutter - Tuerca - Porca	Auto Bloccante Flangiato M8	8DADIAFLN	4
20	Dado - Bolt - Ecrou Mutter - Tuerca - Porca	Auto Bloccante Flangiato M6	6DADIAFLN	1
21	Vite - Screw Vis - Schraube Tornillo - Parafuso	TECF M8x30	830TECF	2
22	Dado - Bolt - Ecrou Mutter - Tuerca - Porca	Autobloccante flangiato M6	6DADIABFN	2
23	Vite - Screw Vis - Schraube Tornillo - Parafuso	TBEI M8x60	860TBEI	2

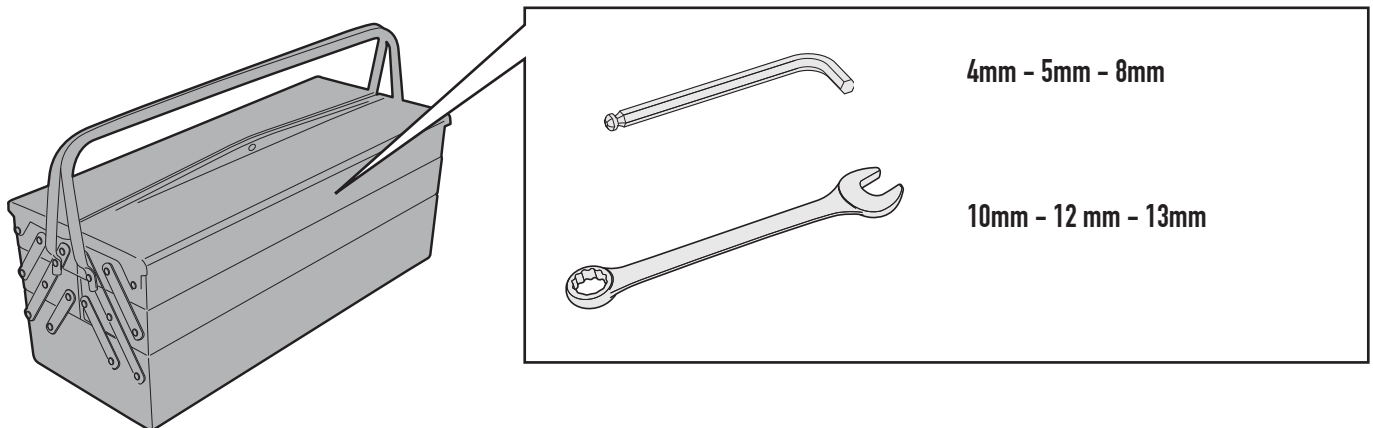

RP7407 - RP7407

PARACOPPA - OIL CARTER PROTECTOR - SABOT MOTEUR - SPEZIFISCHER MOTORSCHUTZ - CUBRE CARTER - CARTER COBRE

DUCATI SCRAMBLER 800 (2015)

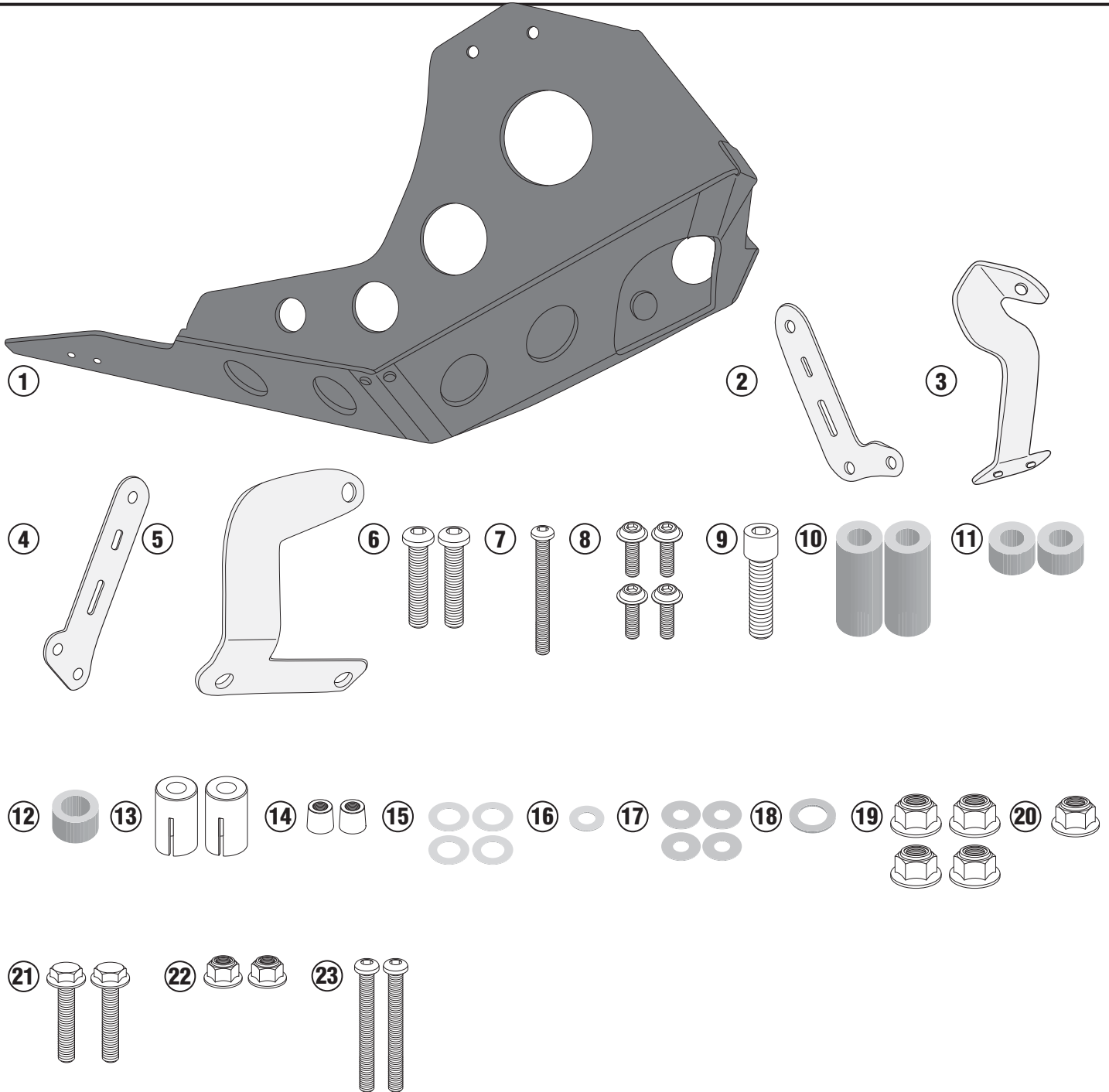

RP7407 - RP7407

PARACOPPA - OIL CARTER PROTECTOR - SABOT MOTEUR - SPEZIFISCHER MOTORSCHUTZ - CUBRE CARTER - CARTER COBRE

DUCATI SCRAMBLER 800 (2015)

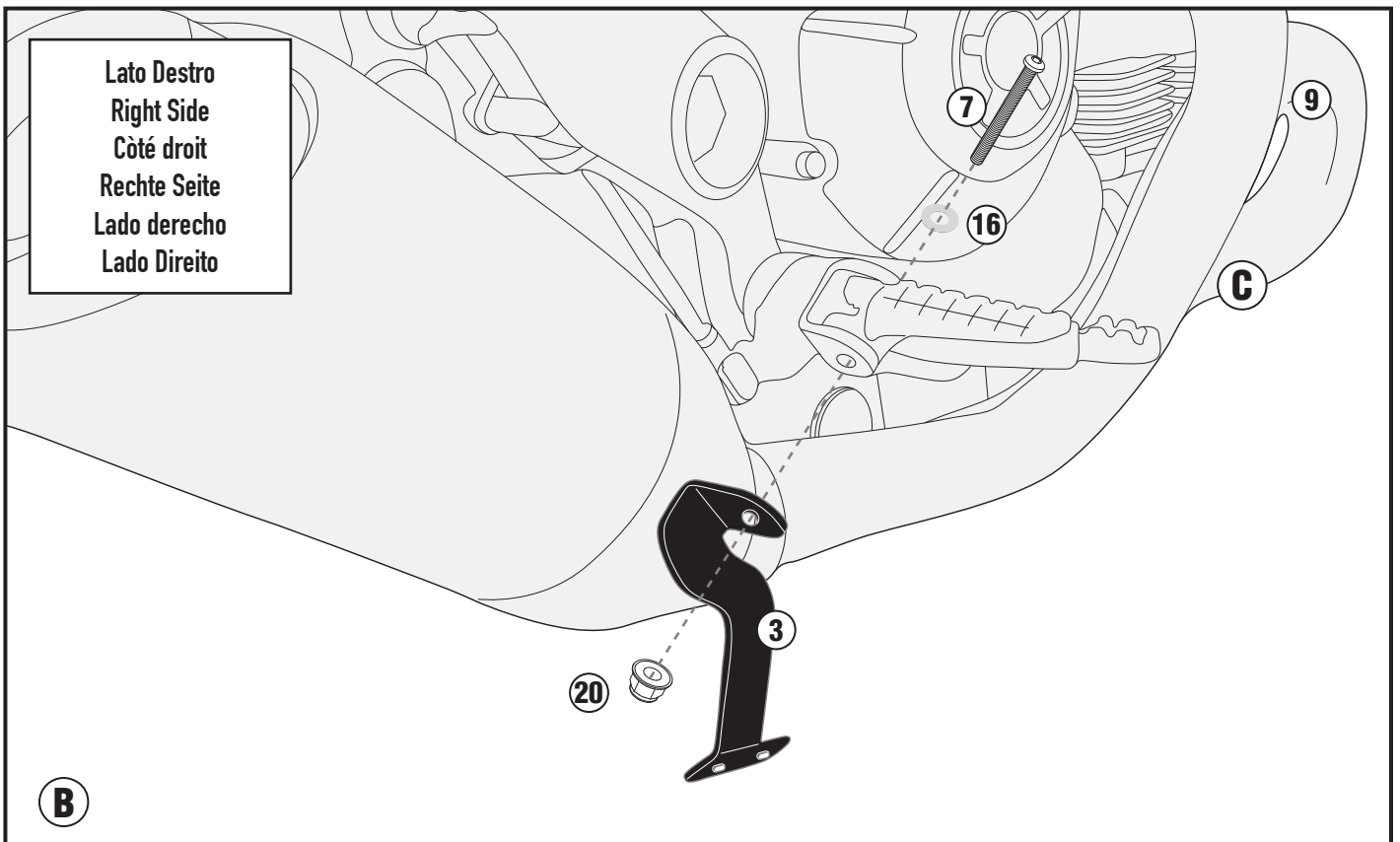
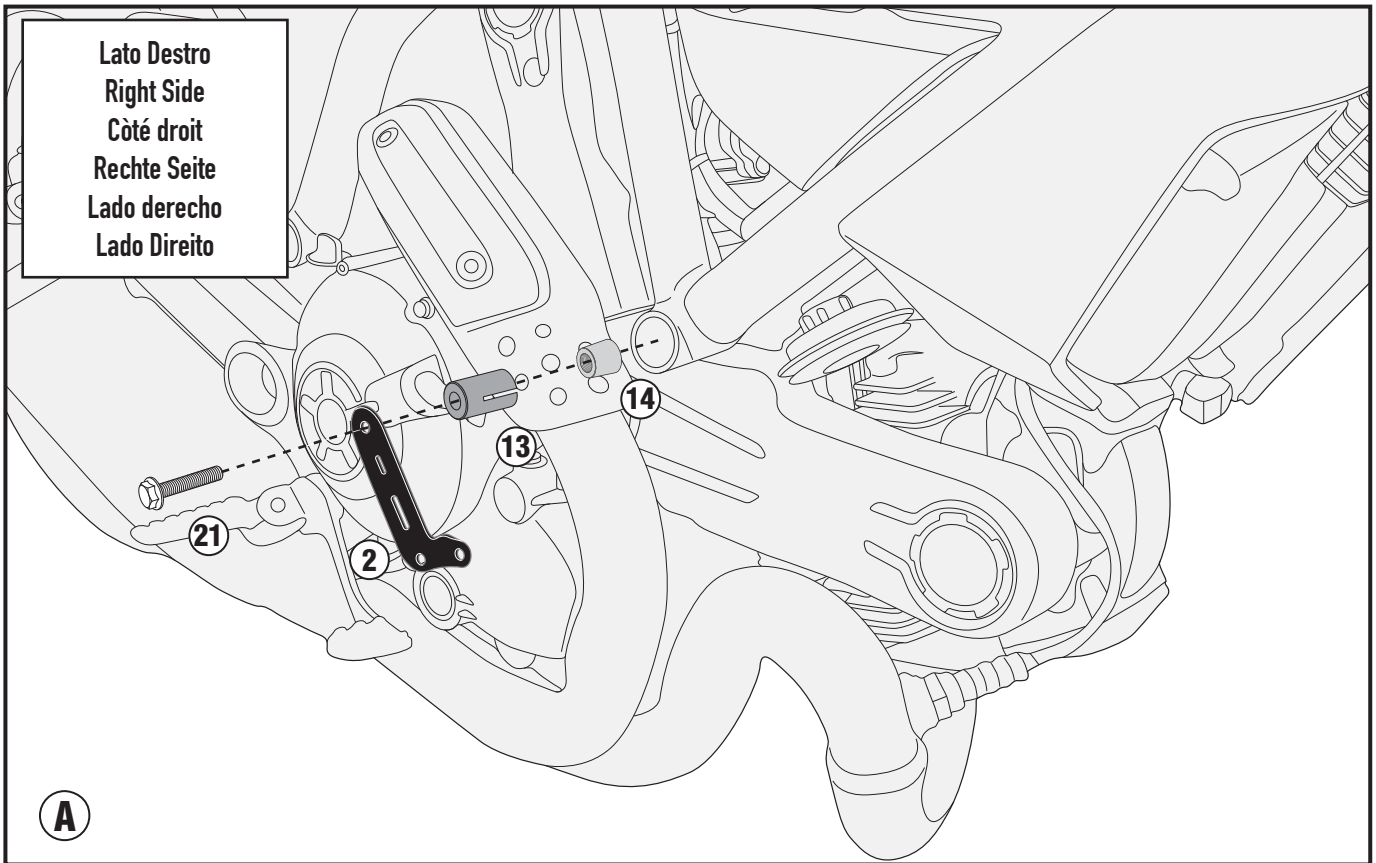

RP7407 - RP7407

PARACOPPA - OIL CARTER PROTECTOR - SABOT MOTEUR - SPEZIFISCHER MOTORSCHUTZ - CUBRE CARTER - CARTER COBRE

DUCATI SCRAMBLER 800 (2015)

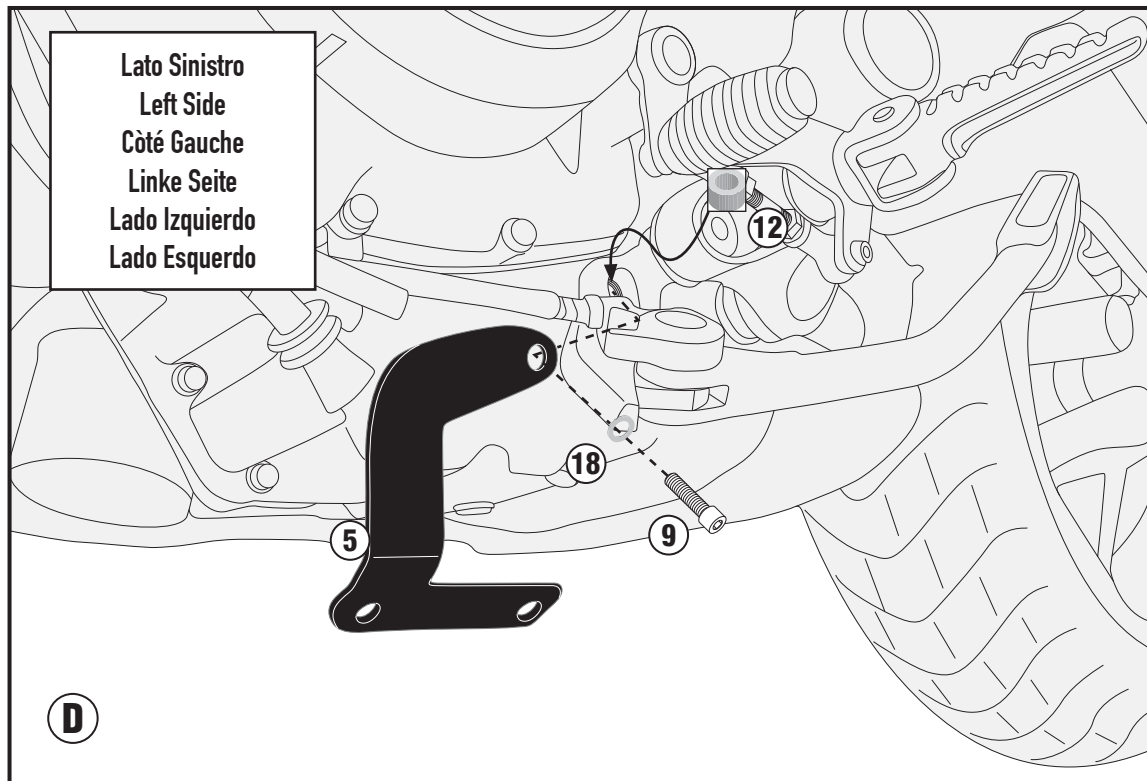
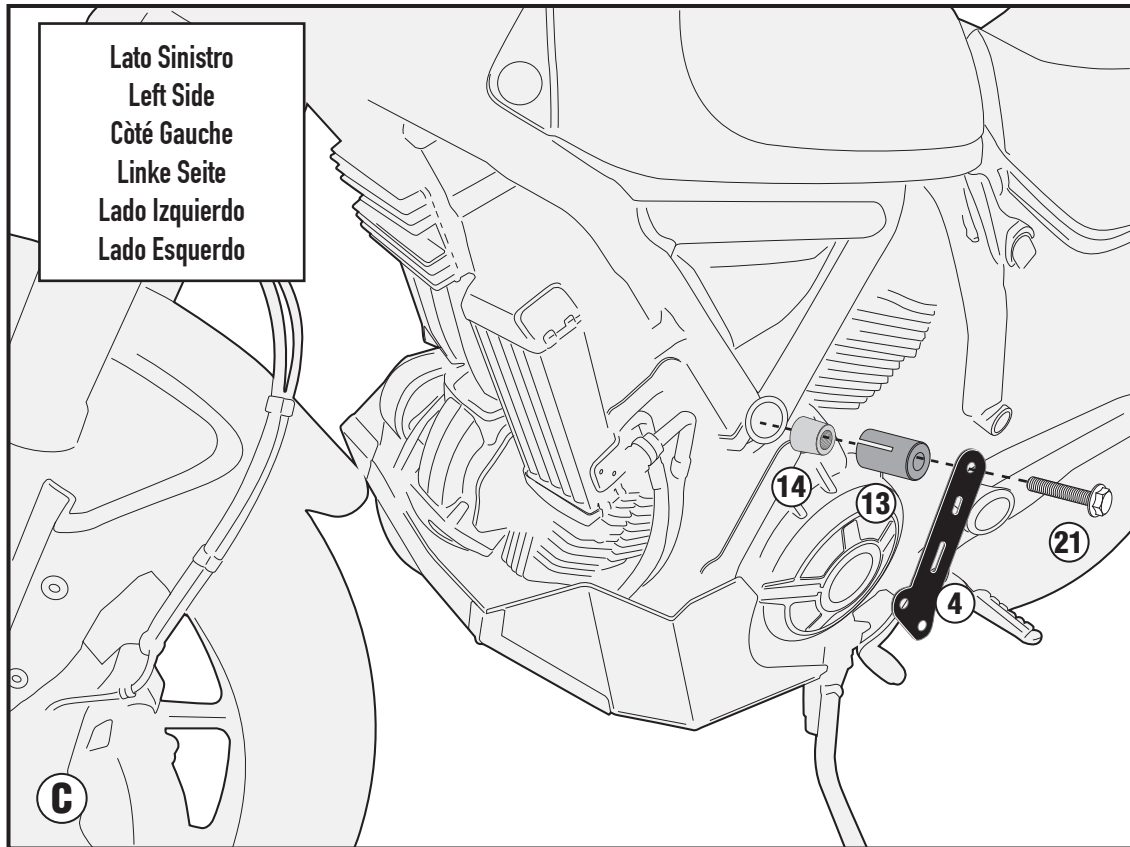

RP7407 - RP7407

PARACOPPA - OIL CARTER PROTECTOR - SABOT MOTEUR - SPEZIFISCHER MOTORSCHUTZ - CUBRE CARTER - CARTER COBRE

DUCATI SCRAMBLER 800 (2015)

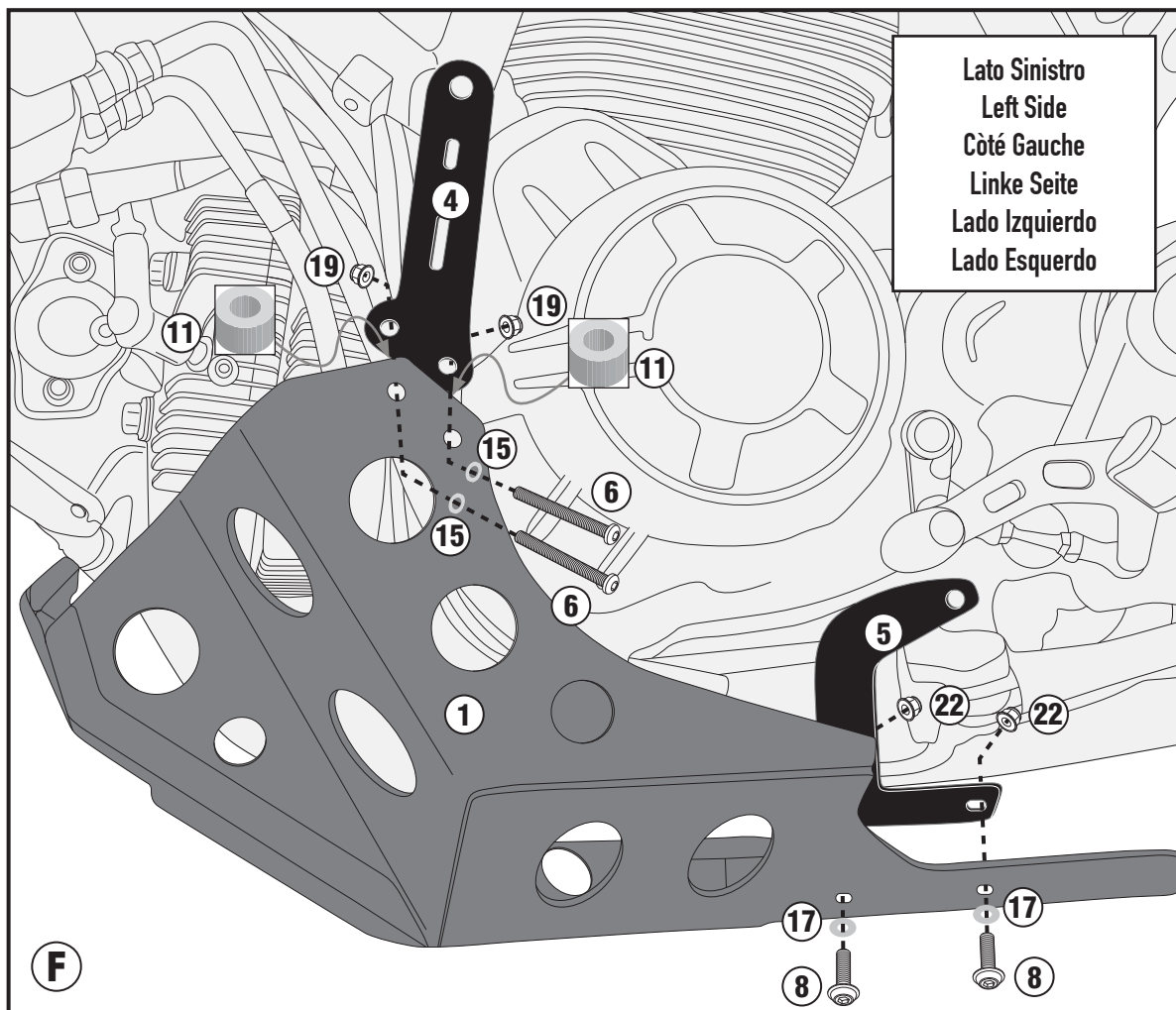
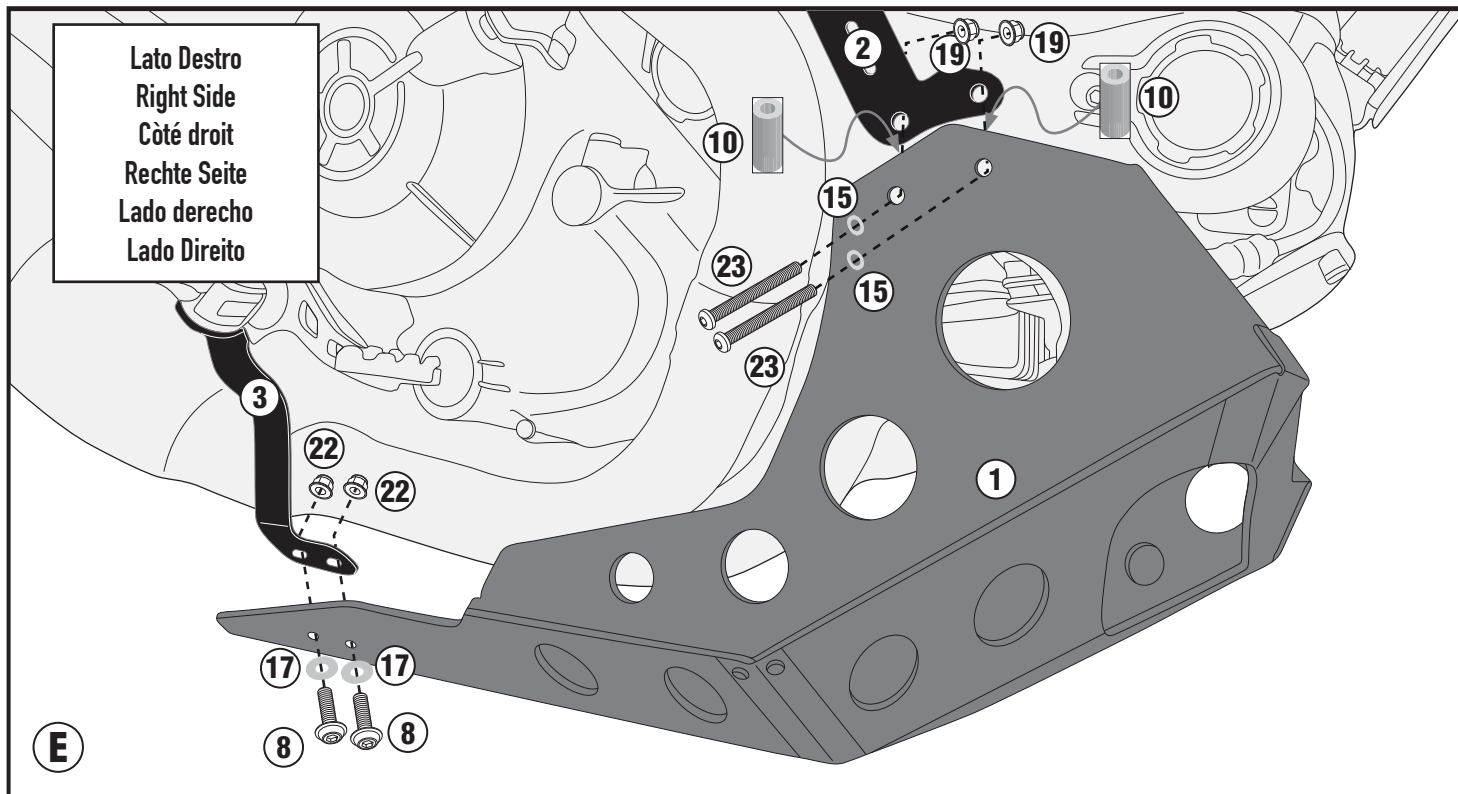

ISTRUZIONI DI MONTAGGIO - MOUNTING INSTRUCTIONS
INSTRUCTIONS DE MONTAGE - BAUANLEITUNG
INSTRUCCIONES DE MONTAJE - INSTRUÇÕES DE MONTAGEM