





443FZ-KZ443

MONORACK SPECIFICO - SPECIFIC MONORACK
 MONORACK SPECIFIQUE - SPECIFISCHES MONORACK - MONORACK ESPECIFICO

KAWASAKI Z750 '04/'05

ISTRUZIONI DI MONTAGGIO - MOUNTING INSTRUCTIONS
 INSTRUCCIONES DE MONTAJE - BAUANLEITUNG - INSTRUCIONES DE MONTAJE

- 
7 V552
 DISTANZIALE Ø20x8
 SPACER
 ENTRETOISE
 DISTANZSTÜCK
 DISTANÇADOR
Q.TY n.2
- 
8 V143
 DISTANZIALE Ø20x4
 SPACER
 ENTRETOISE
 DISTANZSTÜCK
 DISTANÇADOR
Q.TY n.2
- 
9
 VITE TBEI M8x3.5mm
 SCREW M8x3.5mm
 VIS M8x3.5mm
 SCHRAUBE M8x3.5mm
 TORNILLO M8x3.5mm
Q.TY n.2
- 
10
 DADO A.B. M8
 BOIT M8
 ECROU M8
 MUTTER M8
 TUERCA M8
Q.TY n.2

ALLARGARE I FORI SULLE PLASTICHE ORIGINALI FINO AD UN DIAMETRO DI Ø8,5mm
 ENLARGE THE HOLES OF THE ORIGINAL PLASTIC TRAY TO A DIAMETER OF Ø 8,5mm
 AGRANDIR LES TROUS DU PLASTIQUE D'ORIGINE A UN DIAMETRE DE 8,5mm
 BOHREN SIE DIE ORIGINAL PLASTIK ABDECKUNG AUF EINEM DURCHMESSER VON Ø 8,5mm AUF
 AMPLIAR LOS AGUJEROS DE LAS PLÁSTICAS ORIGINALES HASTA LLEGAR A UN DIAMETRO DE 8,5mm

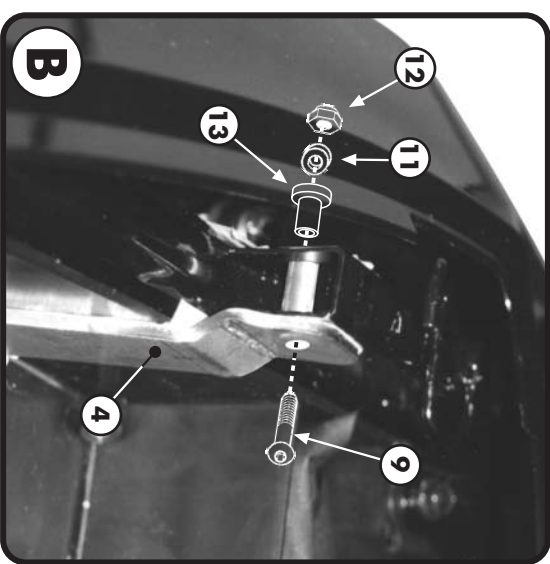
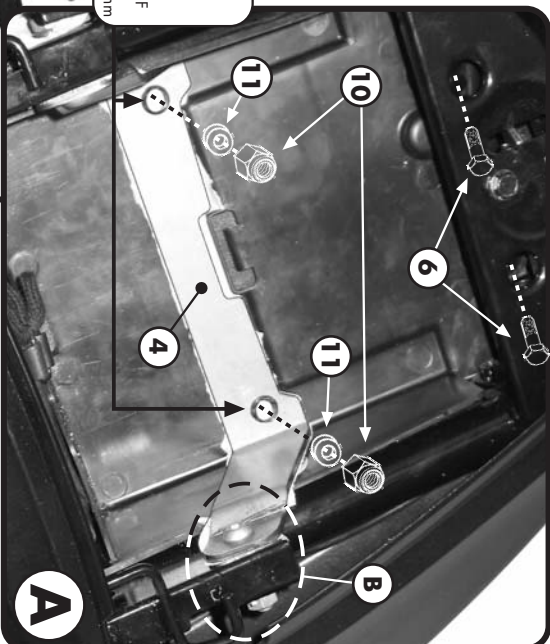
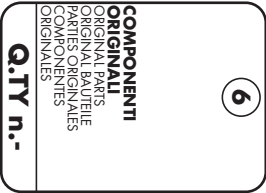
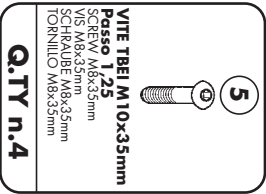
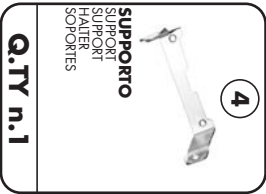
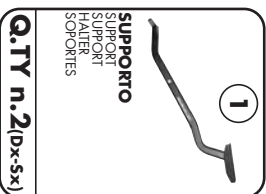
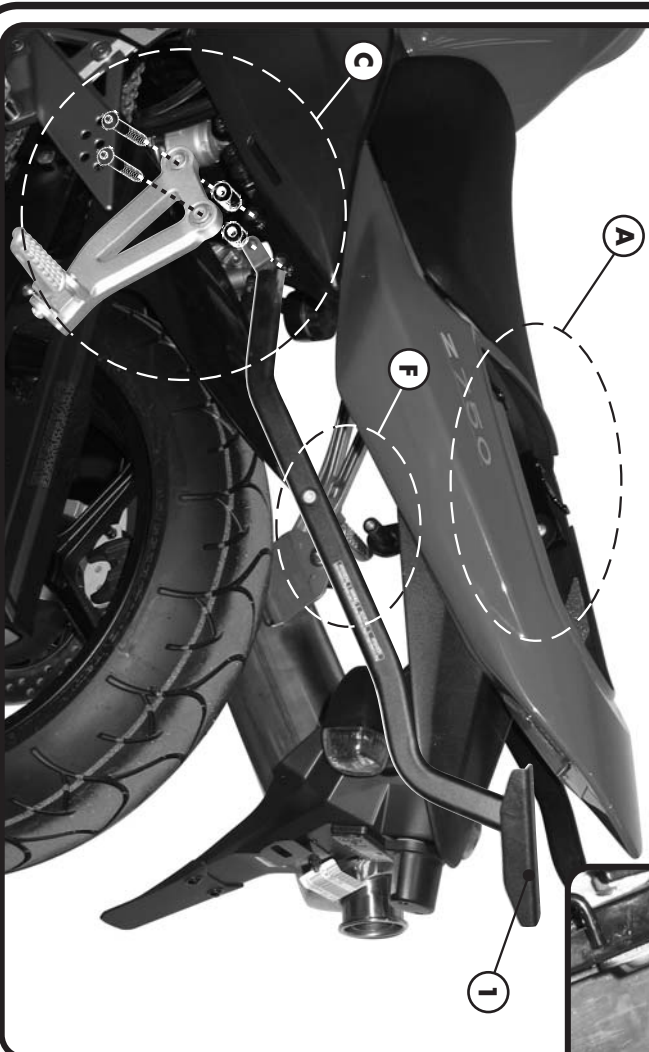

ATTENZIONE: PESO MASSIMO SOPPORTABILE DAL PORTAPACCO 6kg.
WARNING: MAX. LOADING OF THE CARRIER 6kg. (13lbs)
ATTENTION: CHARGE MAXIMALE 6kg.
ACHTUNG: MAXIMALE BELASTUNG DES TRÄGERS 6kg.
ATENCIÓN: CARGA MÁXIMA AUTORIZADA DEL PORTAEQUIPAJE 6kg.

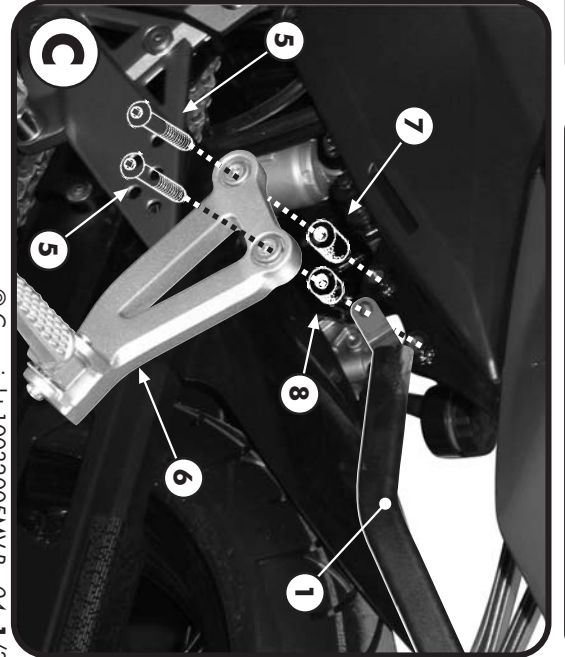



443FZ-KZ443

MONORACK SPECIFICO - SPECIFIC MONORACK
MONORACK SPECIFIQUE - SPEZIFISCHES MONORACK - MONORACK ESPECIFICO

KAWASAKI Z750 '04/'05

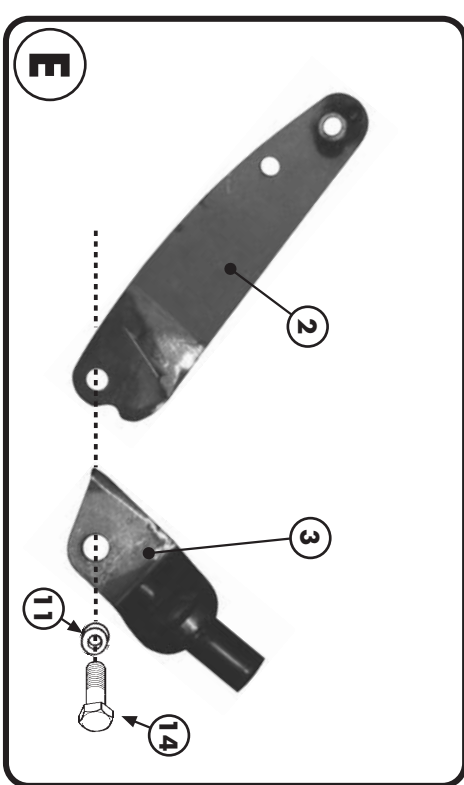
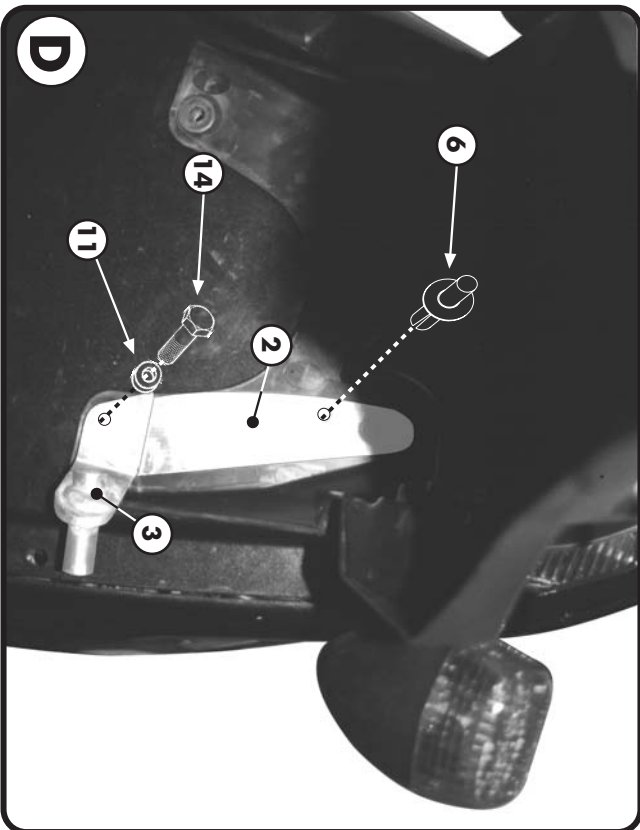
ISTRUZIONI DI MONTAGGIO - MOUNTING INSTRUCTIONS
INSTRUCTIONS DE MONTAGE - BAUANLEITUNG - INSTRUCCIONES DE MONTAJE



11  **RONDELLA Ø8**
WASHER Ø8
RONDELLE Ø8
SCHEIBE Ø8
ARANDELA Ø8

Q.TY n.6

12  **DADO A.B. RIB. M8**
BOLT M8
ECROU M8
MUTTER M8
TUERCA M8

Q.TY n.2

13  **V553**

DISTANZIALE Ø18x23
foro Ø14,3x20mm
SPACER
ENTRETOISE
DISTANZSTUECK
DISTANCIADOR

Q.TY n.2

14  **VITE TE M8x30mm**
SCREW M8x30mm
VIS M8x30mm
SCHRAUBE M8x30mm
TORNILLO M8x30mm

Q.TY n.2

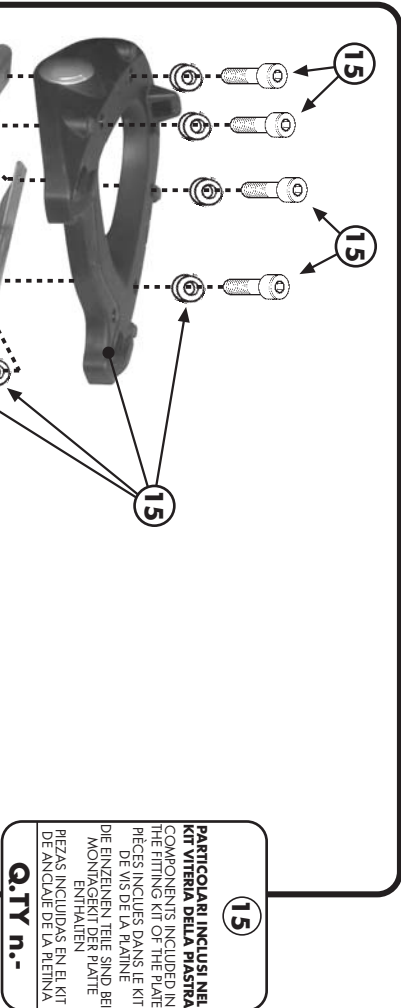
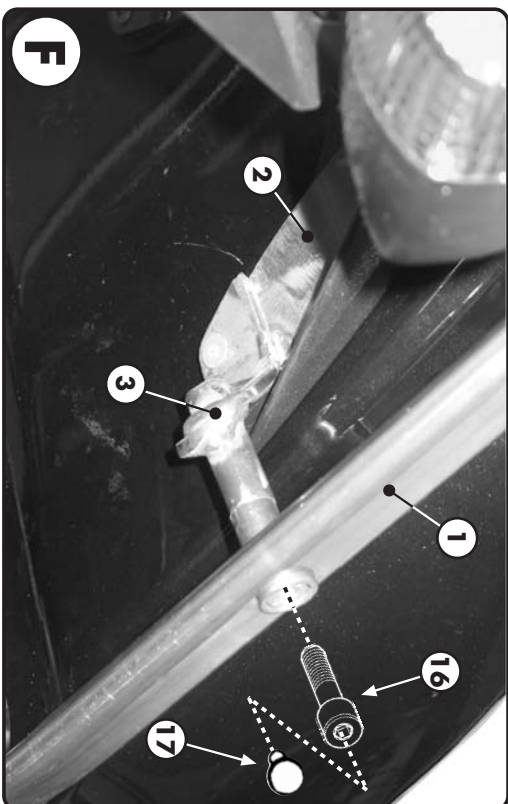

15  **PARTICOLARI INCLUSI NEL KIT VITERIA DELLA PIASTRA**
COMPONENTS INCLUDED IN THE FITTING KIT OF THE PLATE
PIECES INCLUES DANS LE KIT DE VIS DE LA PLATINE
DIE EINZELNEN TEILE SIND BEI MONTAGEKIT DER PLATTE ENTHALTEN
PIEZAS INCLUIDAS EN EL KIT DE ANCLAJE DE LA PLATINA

Q.TY n.-

16  **VITE TCEI M8x25mm**
SCREW M8x25mm
VIS M8x25mm
SCHRAUBE M8x25mm
TORNILLO M8x25mm

Q.TY n.2

17  **COPRIVITE Ø8mm**
SCREW CAP
CACHÉ VIS
STOPSSCHRAUBE
TAPA TORNILLO

Q.TY n.2

443FZ-KZ443

MONORACK SPECIFICO · SPECIFIC MONORACK
MONORACK SPECIFIQUE · SPECIFISCHES MONORACK · MONORACK ESPECIFICO

KAWASAKI Z750 '04/'05

ISTRUZIONI DI MONTAGGIO · MOUNTING INSTRUCTIONS
 INSTRUCTIONS DE MONTAGE · BAUANLEITUNG · INSTRUCCIONES DE MONTAJE

I ISTRUZIONI DI MONTAGGIO

1. POSIZIONARE LA PIASTRA SAGOMATA N°4 (FOTO A), ALLARGARE I FORI INDICATI IN FOTO A FINO AD UN DIAMETRO DI Ø8,5mm; ESEGUIRE IL MONTAGGIO ILLUSTRATO IN FOTO B FACENDO ATTENZIONE AL VERSO INDICATO NELL'INSERIRE IL PARTICOLARE N°13;
2. POSIZIONARE LA PIASTRA N°2 (FOTO D) SOSTITUENDOLA A QUELLA ORIGINALE OCCUPANTE LA STESSA POSIZIONE; SOVRAPPORRE ALLA PIASTRA N°2 IL SUPPORTO N°3 (FOTO E); NOTARE CHE IL BULLONE N°14 SI FISSA STRINGENDO IL DADO N°10 IN FOTO A; RIPOSIZIONARE IL PARTICOLARE N°6 DI FOTO D;
3. ESEGUIRE IL MONTAGGIO INDICATO IN FOTO C;
4. FISSARE LA STAFFA N°1 AL SUPPORTO N°3 COME INDICATO IN FOTO F;
5. MONTARE LA PIASTRA (VENDUTA SEPARATAMENTE) SEGUENDO LE INDICAZIONI DI FOTO G E COMPLETANDO CON LE ISTRUZIONI CONTENUTE NELLA SUA CONFEZIONE;
6. ULTIMARE IL MONTAGGIO SERRANDO BENE TUTTE LE VITI.

E MOUNTING INSTRUCTIONS

1. PLACE THE SUPPORT N°4 (PICTURE A) AND ENLARGE THE HOLES SHOWN IN THE PICTURE TO A DIAMETER OF Ø 8.5 MM. NOW PROCEED WITH THE MOUNTING AS SHOWN IN PICTURE B PAYING ATTENTION TO THE POSITION OF PART N°13;
2. PLACE THE PLATE N°2 (PICTURE D) REPLACING THE ORIGINAL PLATE. THEN PLACE THE SUPPORT N°3 (PICTURE E) ON THE PLATE N°2. PLEASE NOTE THAT THE SCREW N°14 IS FIXED BY TIGHTENING THE BOLT N°10 IN PICTURE A. LASTLY RE-POSITION THE PART N°6 OF PICTURE D;
3. PROCEED WITH THE MOUNTING AS SHOWN IN PICTURE C;
4. FIX THE SIDE SUPPORT N°1 TO THE SUPPORT N°3 AS SHOWN IN PICTURE F;
5. NOW MOUNT THE PLATE (SOLD SEPARATELY) AS SHOWN IN PICTURE G AND FOLLOWING THE MOUNTING INSTRUCTION INCLUDED IN ITS BOX.
6. LASTLY TIGHTEN ALL THE SCREWS.

F INSTRUCTIONS DE MONTAGE

1. POSITIONNER LE SUPPORT PROFILE N°4 (PHOTO A), AGRANDIR LES TROUS INDIQUEES SUR LA PHOTO A, UN DIAMETRE DE 8,5MM; FAIRE LE MONTAGE ILLUSTRE SUR LA PHOTO B EN FAISANT ATTENTION AU SENS D'INSERTION DE LA PIECE N°13;
2. POSITIONNER LA PIECE N°2 (PHOTO D) A LA PLACE DE LA PIECE ORIGINALE SUIVEE A CET ENDROIT; SUPERPOSER LE SUPPORT N°3 SUR LA PIECE N°2 (PHOTO E); NOTER QUE LA VIS N°14 EST FIXEE PAR L'ECROU N°10 DE LA PHOTO A; REPOSITIONNER LA PIECE N°6 DE LA PHOTO D;
3. PROCEDER AU MONTAGE INDIQUE SUR LA PHOTO C;
4. FIXER LES BRAS N°1 AUX SUPPORTS N°3 COMME INDIQUE SUR LA PHOTO F;
5. MONTER LA PLATINE (VENDUE SEPAREMENT) EN SUIVANT LES INDICATIONS DE LA PHOTO G COMPLETEES PAR LES INSTRUCTIONS LIVREES AVEC CELLE-CI.
6. FINIR LE MONTAGE EN SERRANT BIEN TOUTES LES VIS.

D BAUANLEITUNG

1. POSITIONIEREN SIE DEN HALTER NR. 4 (BILD A). BOHREN SIE DURCH DEN HALTER NR. 4 DIE LOCHER (BILD A) MIT EINEM DURCHMESSER VON Ø 8,5 MM. BEI DER MONTAGE VOM BILD B ACHTEN SIE AUF DIE POSITION DES TEILES NR. 13;
2. ERSETZEN SIE DEN ORIGINAL HALTER DURCH DEN HALTER NR. 2 (BILD D). VERSCHRAUBEN SIE DAS TEIL NR. 3 MIT DEM HALTER NR. 2 (BILD E). VERWENDEN SIE DAZU DIE SCHRAUBE NR. 14 UND DIE MUTTER NR. 10 (BILD A). POSITIONIEREN SIE DAS TEIL NR. 6 (BILD D) WIEDER AM URSPRÜNGLICHEN PLATZ.
3. GEHEN SIE MIT DER MONTAGE WEITER IM BILD C BESCHRIEBEN.
4. MONTIEREN SIE DEN HALTER NR. 1 AN DEN HALTER NR. 3 WIE IM BILD F BESCHRIEBEN.
5. MONTIEREN SIE DIE PLATTE (IST SEPARAT ZU BESTELLEN) WIE IM BILD G BESCHRIEBEN. BEACHTEN SIE DIE BAUANLEITUNG, DIE MIT DER PLATTE MITGELIEFERT WIRD.
7. ZULETZT ZIEHEN SIE ALLE SCHRAUBEN FEST.

ES

1. POSICIONAR EL SOPORTE SAGOMADO N° 4 COMO INDICA LA FOTO A. ESANCHAR LOS AGUJEROS DEL CARENADO HASTA CONSEGUIR UN DIAMETRO DE 8,5 MMS.. MONTAR LA PARRILLA COMO INDICA LA FOTO B, PONIENDO ATENCION EN POSICIONAR EN LA CORRECTA DIRECCION EL DISTANCIADOR N°13;
2. POSICIONAR EL SOPORTE N° 2 COMO INDICA LA FOTO D SUBSTITUYENDO EL ORIGINAL, SOBREPONER EL SOPORTE N° 3 AL SOPORTE N° 2 COMO INDICA A FOTO E. TENIENDO EN CUENTA QUE EL TORNILLO N° 14 SE COMBINA CON LA TUERCA N° 10 (VER FOTO A), VOLVER A POSICIONAR EL DESPIECE N° 6 COMO INDICA LA FOTO D;
3. EJECUTAR EL MONTAJE INDICADO EN LA FOTO C;
4. ANCLAR EL BRAZO MONORACK N° 1 AL SOPORTE N° 3 COMO INDICA LA FOTO F;
5. MONTAR LA PARRILLA (NO INCLUIDA - SE VENDE POR SEPARADO) SEGUN LAS INSTRUCCIONES INDICADAS POR LA FOTO G Y TENIENDO EN CUENTA LAS INSTRUCCIONES INCLUIDAS EN LA CONFECCION DE LA PARRILLA MISMA;
6. TERMINAR APRETANDO BIEN TODOS LOS TORNILLOS

INSTRUCCIONES DE MONTAJE