

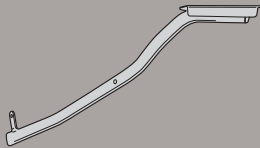







# 4104FZ - KZ4104

MONORACK SPECIFICO - SPECIFIC MONORACK - MONORACK SPECIFIQUE - SPEZIFISCHES MONORACK - MONORACK ESPECÍFICO

## KAWASAKI ER-6n/ER-6f 2012

N°	Descrizione	Caratteristiche	Codice	Quantità	
1	Supporto - Blinker Support Support - Halter - Soporte	-	-	2 (Dx;Sx)	
2	Supporto - Blinker Support Support - Halter - Soporte	-	GL2066	2 (Dx,Sx)	
3	Dado - Bolt - Ecrou Mutter - Tuerca	Auto Bloccante Flangiato M8	-	2	
4	Vite - Screw Vis - Schraube Tornillo	TEF M6x20		2	
5	Vite - Screw Vis - Schraube Tornillo	TCEI M8x25		2	
6	Vite - Screw Vis - Schraube Tornillo	TEF M8x50		2	
7	Distanziale - Spacer Entretoise - Distanzstueck Distanciador	Ø10x3 foro6.5mm	V714	2	
8	Coprivite - Screw Cap Cache Vis - Stopsschraube Tapa Tornillo	Ø8	Z801	2	
9	Rondella - Washer Rondelle - Scheibe Arandela	Ø6x20		2	
10	Particolari Inclusi Nel Kit Viteria Della Piastra Components Included In The Fitting Kit Of The Plate Pièces Incluses Dans Le Kit De Vis De La Platine Die Einzelnen Teile Sind Bei Montagekit Der Platte Enthalten Despieces Incluidos En El Kit De Anclajes De La Parrilla				

# 4104FZ - KZ4104

MONORACK SPECIFICO - SPECIFIC MONORACK - MONORACK SPECIFIQUE - SPEZIFISCHES MONORACK - MONORACK ESPECÍFICO

## KAWASAKI ER-6n/ER-6f 2012

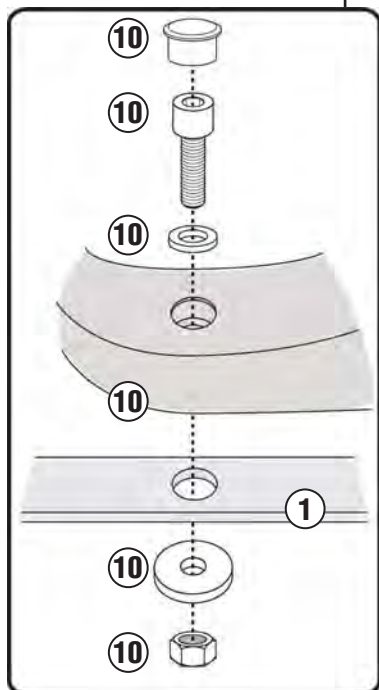
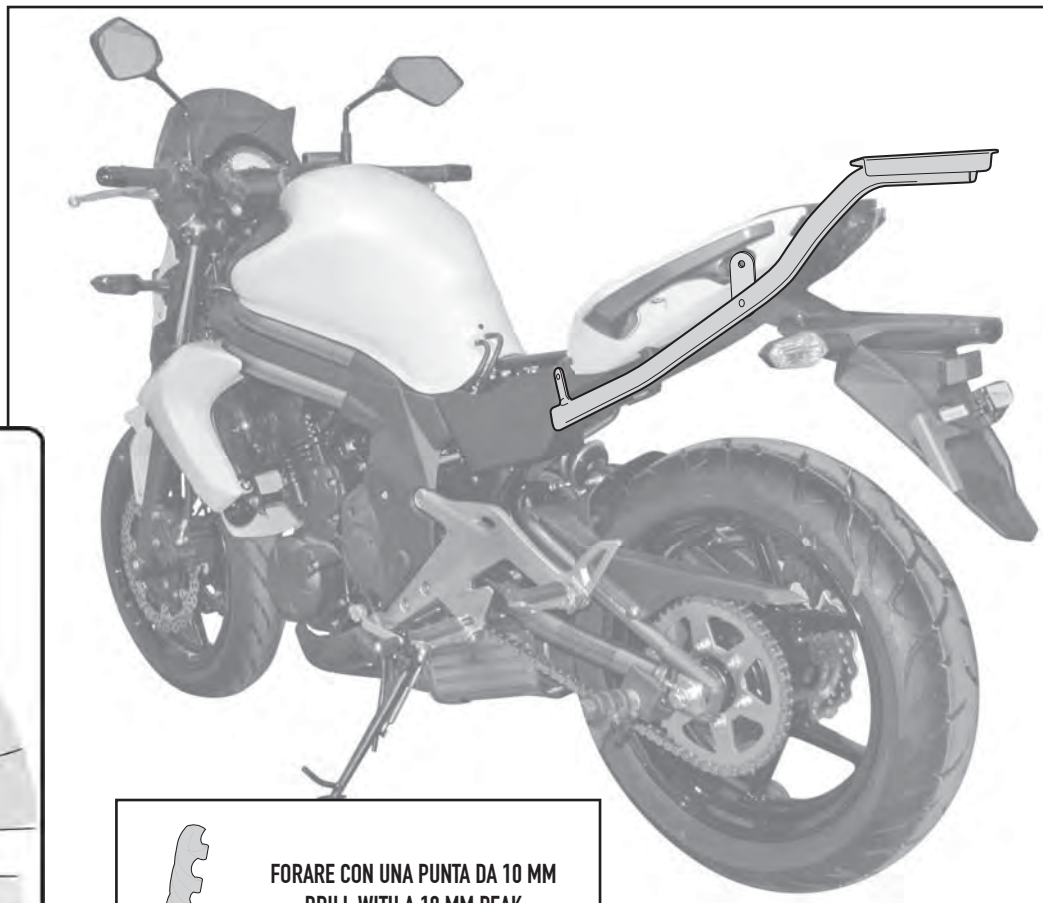

FORARE CON UNA PUNTA DA 10 MM  
DRILL WITH A 10 MM PEAK  
PERCEZ AVEC UN PIC DE 10 MM  
LÖCHER MIT EINEM 10 MM SPITZE  
PERFORAR CON UN PICO DE 10 MM

