

MONORACK SPECIFICO - SPECIFIC MONORACK
MONORACK SPECIFIQUE - SPEZIFISCHES MONORACK - MONORACK ESPECÍFICO

HONDA CROSSRUNNER 800 2011

ISTRUZIONI DI MONTAGGIO - MOUNTING INSTRUCTIONS
INSTRUCTIONS DE MONTAGE - BAUANLEITUNG - INSTRUCCIONES DE MONTAJE

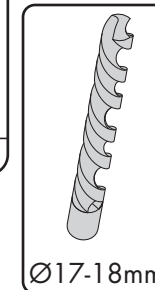
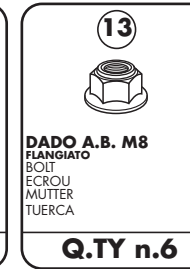
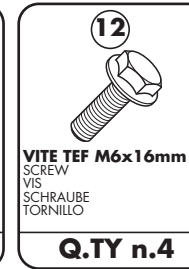
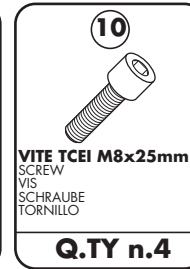
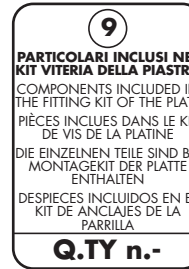
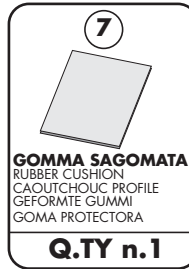
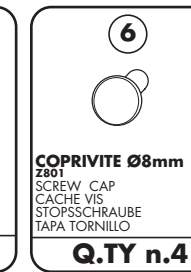
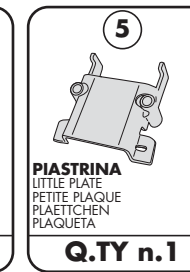
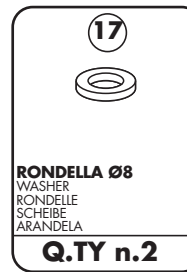
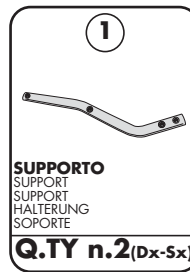

- . Posizionare il supporto n°5, marcare il punto di appoggio delle 2 boccole e forare con una punta da 17-18mm;
- . Place support n°5, drill where the spacers touch the tail of the motorbike. (Use a 17-18mm point) ;
- . Positionieren Sie die Halterung Nr. 5, markieren Sie die Stelle der 2 Buchsen und bohren Sie mit einem Bohrer mit Durchmesser 17-18mm;
- . Positionner le support n° 5, marquer les point de perçage et percer avec un foret de 17-18 mm;
- . Posicionar el soporte N° 5, marcar el punto de apoyo de las 2 arandelas y agujerear con una punta de 17-18mm;

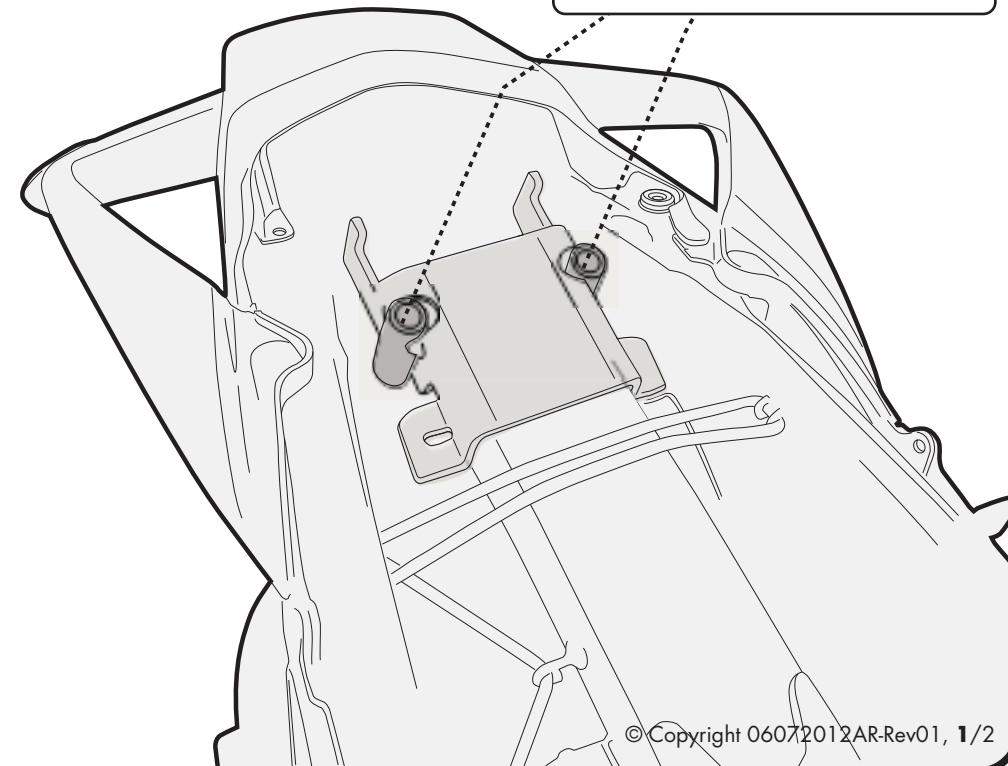
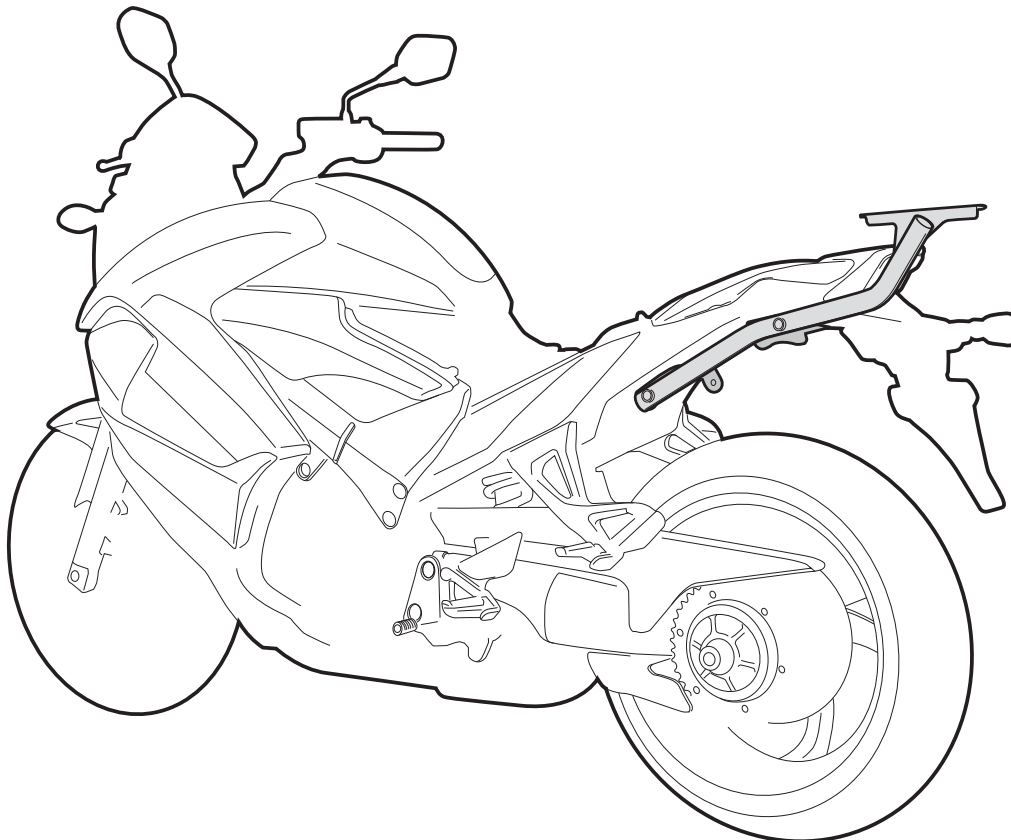

1104FZ-KZ1104

MONORACK SPECIFICO - SPECIFIC MONORACK
MONORACK SPECIFIQUE - SPEZIFISCHES MONORACK - MONORACK ESPECÍFICO

HONDA CROSSRUNNER 800

2011

ISTRUZIONI DI MONTAGGIO - MOUNTING INSTRUCTIONS
INSTRUCTIONS DE MONTAGE - BAUANLEITUNG - INSTRUCCIONES DE MONTAJE

