

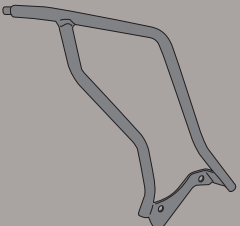

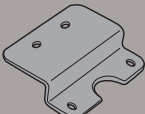

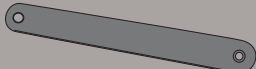

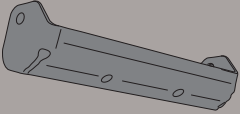

SR2113 - KR2113

PORTAPACCO SPECIFICO - SPECIFIC HOLDER - PORTE-PAQUET SPÉCIFIQUE - SPEZIFISCHER TRÄGER - PORTA-EQUIPAJE ESPECÍFICO - TRANSPORTADOR ESPECÍFICO

YAMAHA AEROX R 50 (2013)

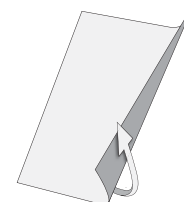

N°	Descrizione	Caratteristiche	Codice	Quantità	
1	Supporto - Support - Support Halterung - Soporte - Apoio	-	SR2113SX/DX	2 (Dx:Sx)	
2	Supporto - Support - Support Halterung - Soporte - Apoio	Sp. 3mm	GL2492P	1	
3	Supporto - Support - Support Halterung - Soporte - Apoio	Sp. 2mm	GL2493S	2 (Dx:Sx)	
4	Supporto - Support - Support Halterung - Soporte - Apoio	Sp. 3mm	GL2490P	1	
5	Vite - Screw Vis - Schraube Tornillo - Parafuso	TEF M6x25	625TEF	2	
6	Vite - Screw Vis - Schraube Tornillo - Parafuso	TE M6x35	635TEN	4	
7	Vite - Screw Vis - Schraube Tornillo - Parafuso	TECF M8x20	820TECF	2	
8	Vite - Screw Vis - Schraube Tornillo - Parafuso	TCEI M6x25	625TCE	6	
9	Rondella - Washer Rondelle - Scheibe Arandela - Arruela	Ø6	6RON	6	
10	Supporto - Support - Support Halterung - Soporte - Apoio	-	GN522	2	
11	Dado - Bolt - Ecrou Mutter - Tuerca - Porca	Dado Auto Bloccante Flangiato M8	8DADIAFLN	2	
12	Dado - Bolt - Ecrou Mutter - Tuerca - Porca	Dado Auto Bloccante Flangiato M6	6DADIAFLN	2	



SR2113 - KR2113

PORTAPACCO SPECIFICO - SPECIFIC HOLDER - PORTE-PAQUET SPÉCIFIQUE - SPEZIFISCHER TRÄGER - PORTA-EQUIPAJE ESPECÍFICO - TRANSPORTADOR ESPECÍFICO

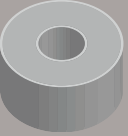
YAMAHA AEROX R 50 (2013)

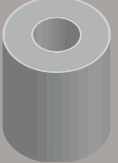
N°	Descrizione	Caratteristiche	Codice	Quantità	
13	Distanziale - Spacer Entretoise - Distanzstueck Distanciador - Espaçador	Ø16x6 Foro 6,5mm	C16L6F6,5T	2	
14	Distanziale - Spacer Entretoise - Distanzstueck Distanciador - Espaçador	Ø10x4 Foro 6mm	C10L4F6T	4	
15	Distanziale - Spacer Entretoise - Distanzstueck Distanciador - Espaçador	Ø16x18 Foro 6,5mm	C16L18F6,5T	2	
16	Distanziale - Spacer Entretoise - Distanzstueck Distanciador - Espaçador	Ø14x12 Foro 6,5mm	C14L12F6,5T	2	
17	Particolari Inclusi Nel Kit Viteria Della Piastra Components Included In The Fitting Kit Of The Plate Pièces Incluses Dans Le Kit De Vis De La Platine Die Einzelnen Teile Sind Bei Montagekit Der Platte Enthalten Despieces Incluidos En El Kit De Anclajes De La Parrilla Explodiu incluído no Kit as âncoras da grelha	-	-	-	-

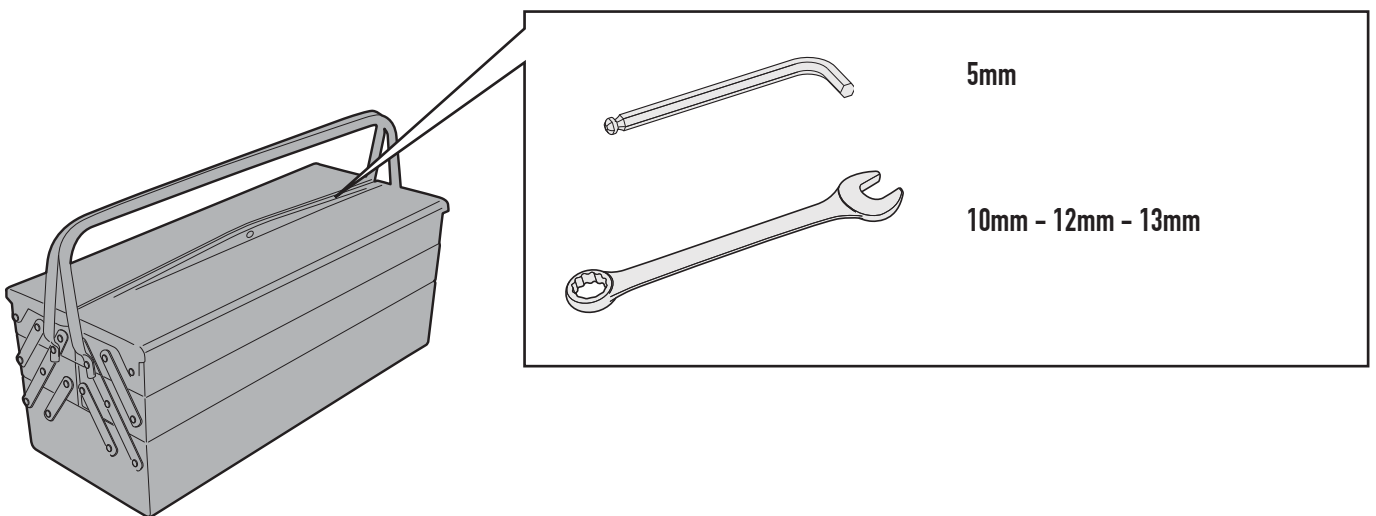

SR2113 - KR2113

PORTAPACCO SPECIFICO - SPECIFIC HOLDER - PORTE-PAQUET SPÉCIFIQUE - SPEZIFISCHER TRÄGER - PORTA-EQUIPAJE ESPECÍFICO - TRANSPORTADOR ESPECÍFICO

YAMAHA

AEROX R 50

(2013)

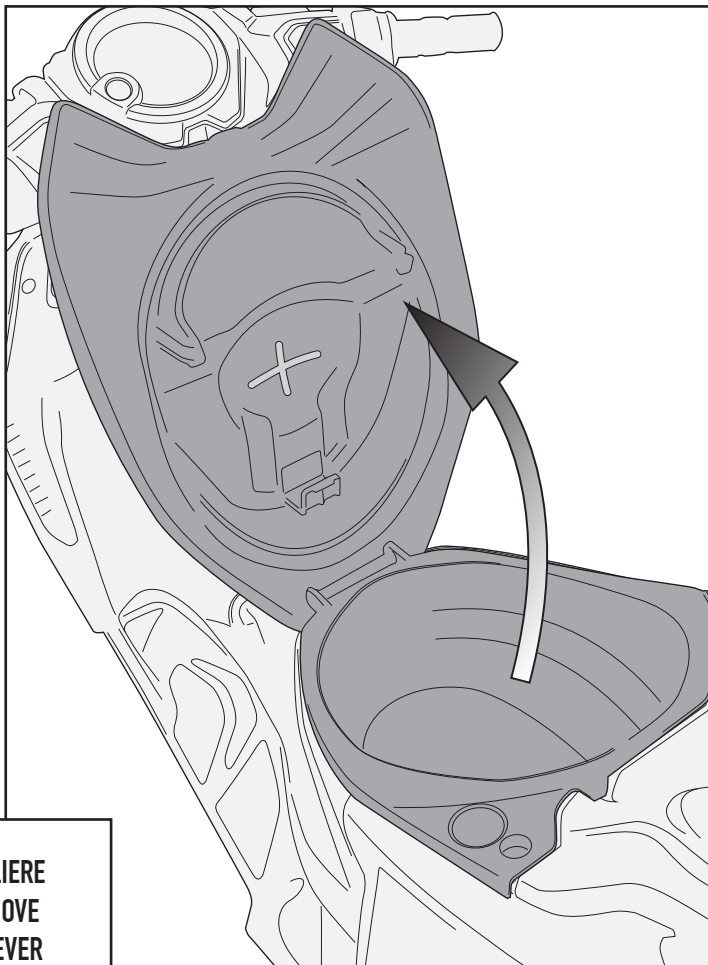
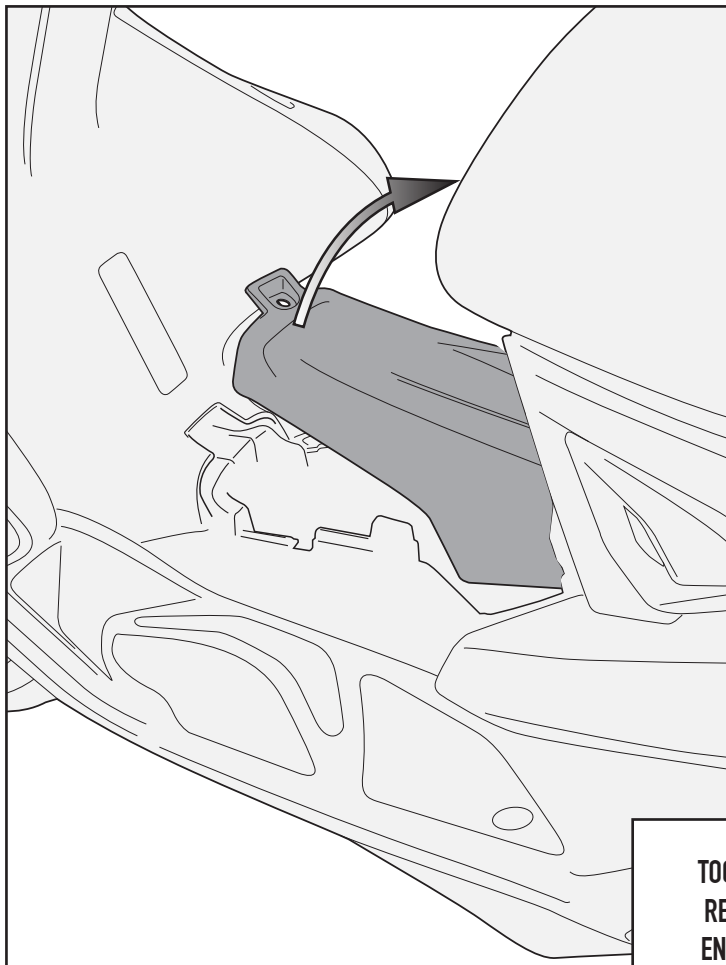

TOGLIERE
REMOVE
ENLEVER
ENTFERNEN
QUITAR
REMOVER

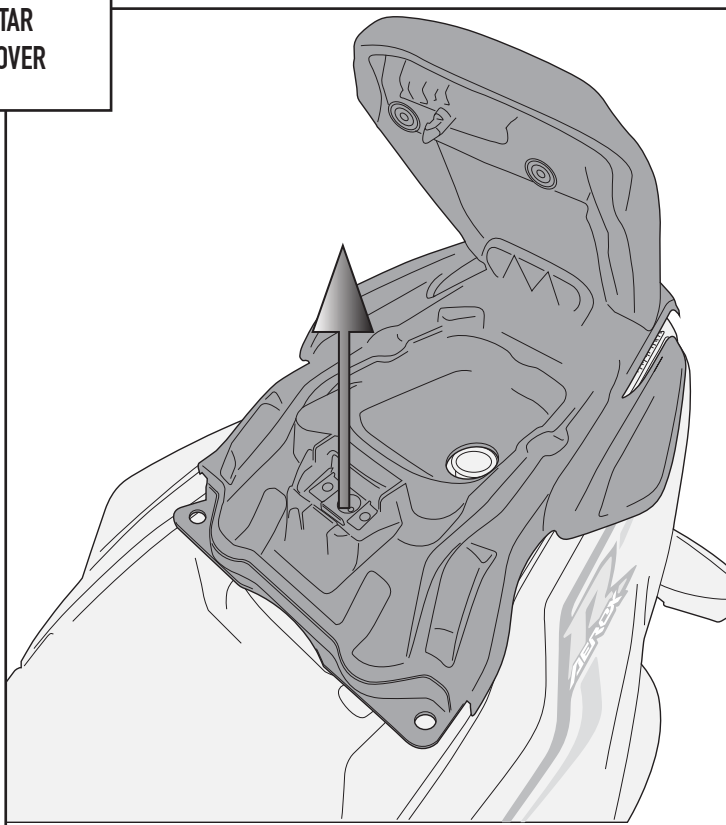
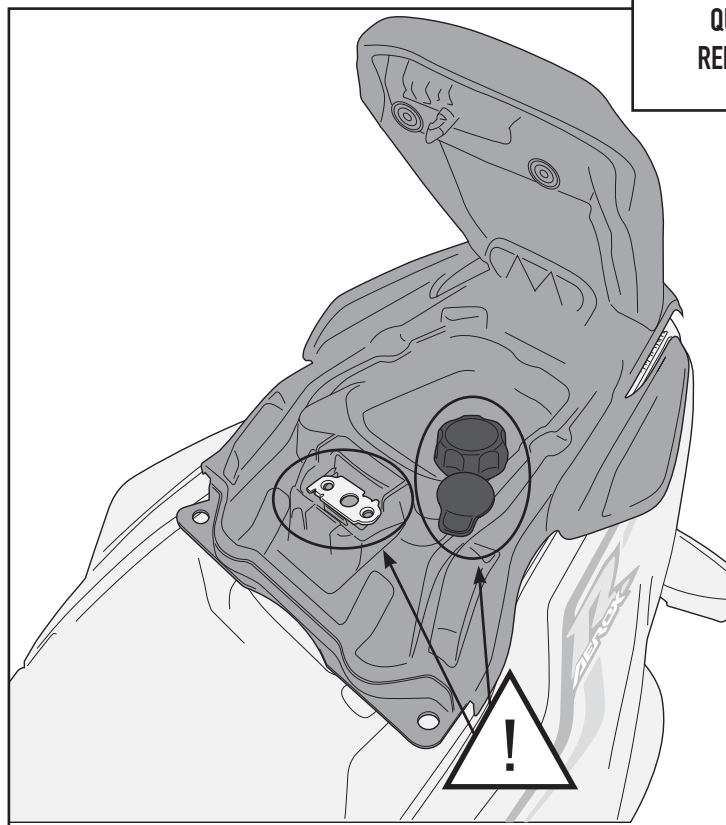

ISTRUZIONI DI MONTAGGIO - MOUNTING INSTRUCTIONS
INSTRUCTIONS DE MONTAGE - BAUANLEITUNG
INSTRUCCIONES DE MONTAJE - INSTRUÇÕES DE MONTAGEM

SR2113 - KR2113

PORTAPACCO SPECIFICO - SPECIFIC HOLDER - PORTE-PAQUET SPÉCIFIQUE - SPEZIFISCHER TRÄGER - PORTA-EQUIPAJE ESPECÍFICO - TRANSPORTADOR ESPECÍFICO

YAMAHA

AEROX R 50

(2013)

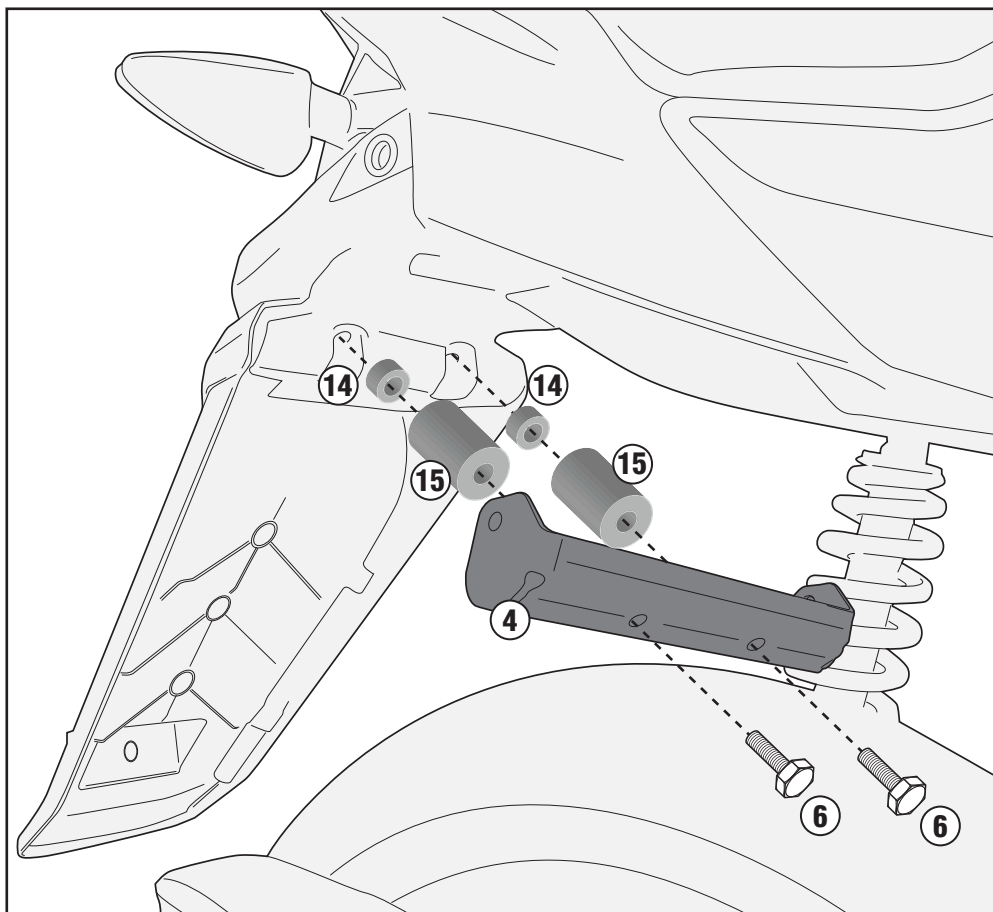
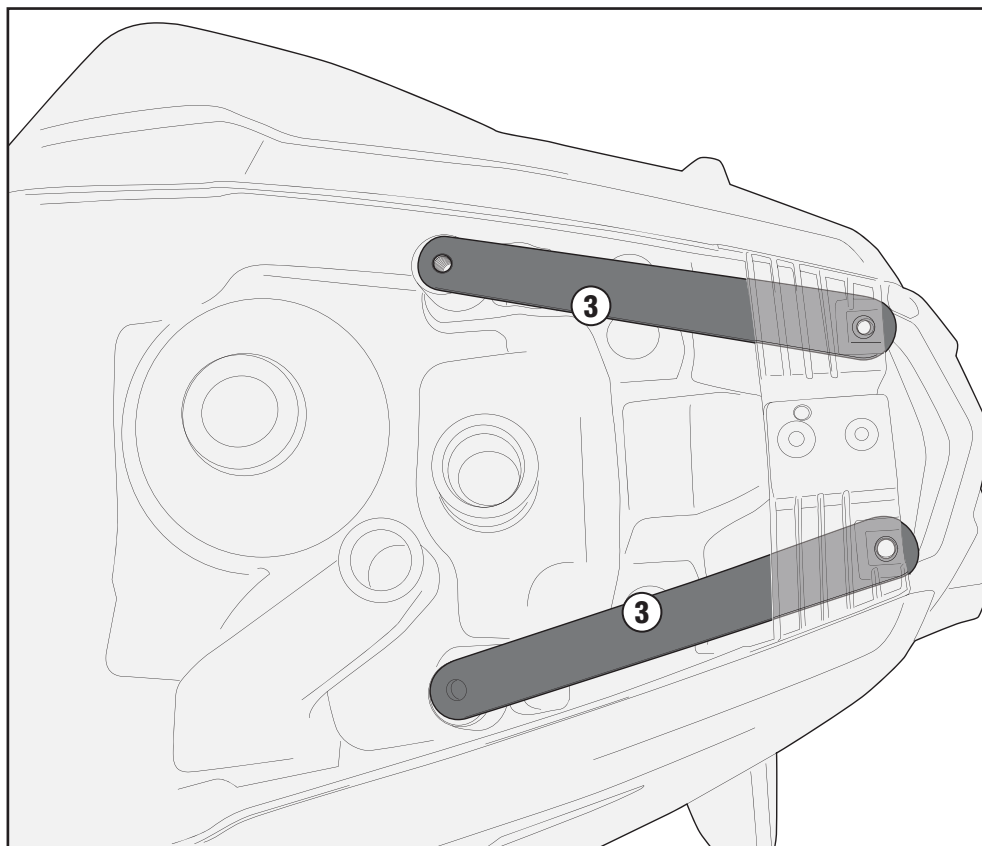

ISTRUZIONI DI MONTAGGIO - MOUNTING INSTRUCTIONS
INSTRUCTIONS DE MONTAGE - BAUANLEITUNG
INSTRUCCIONES DE MONTAJE - INSTRUÇÕES DE MONTAGEM

SR2113 - KR2113

PORTAPACCO SPECIFICO - SPECIFIC HOLDER - PORTE-PAQUET SPÉCIFIQUE - SPEZIFISCHER TRÄGER - PORTA-EQUIPAJE ESPECÍFICO - TRANSPORTADOR ESPECÍFICO

YAMAHA

AEROX R 50

(2013)

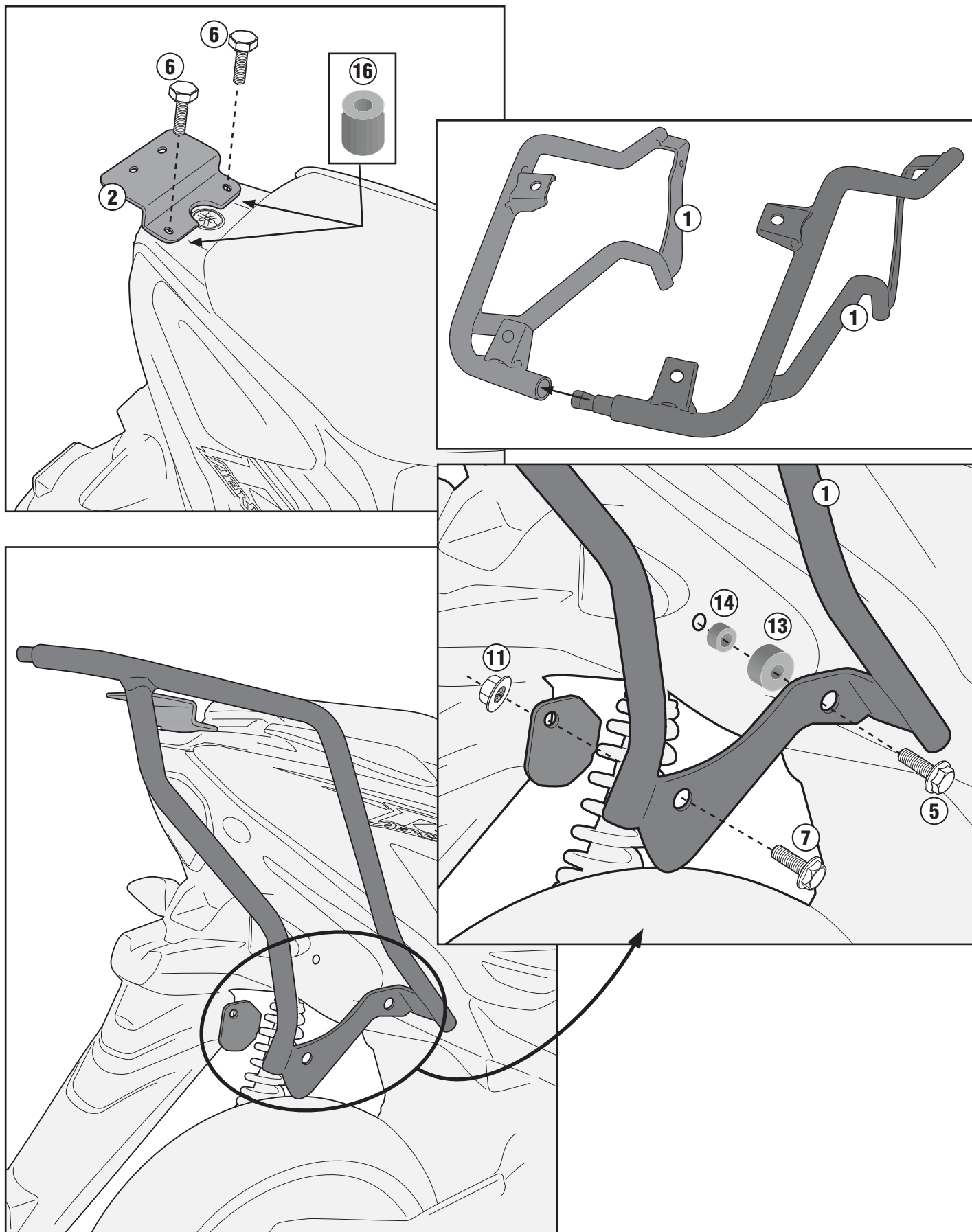

SR2113 - KR2113

PORTAPACCO SPECIFICO - SPECIFIC HOLDER - PORTE-PAQUET SPÉCIFIQUE - SPEZIFISCHER TRÄGER - PORTA-EQUIPAJE ESPECÍFICO - TRANSPORTADOR ESPECÍFICO

YAMAHA

AEROX R 50

(2013)

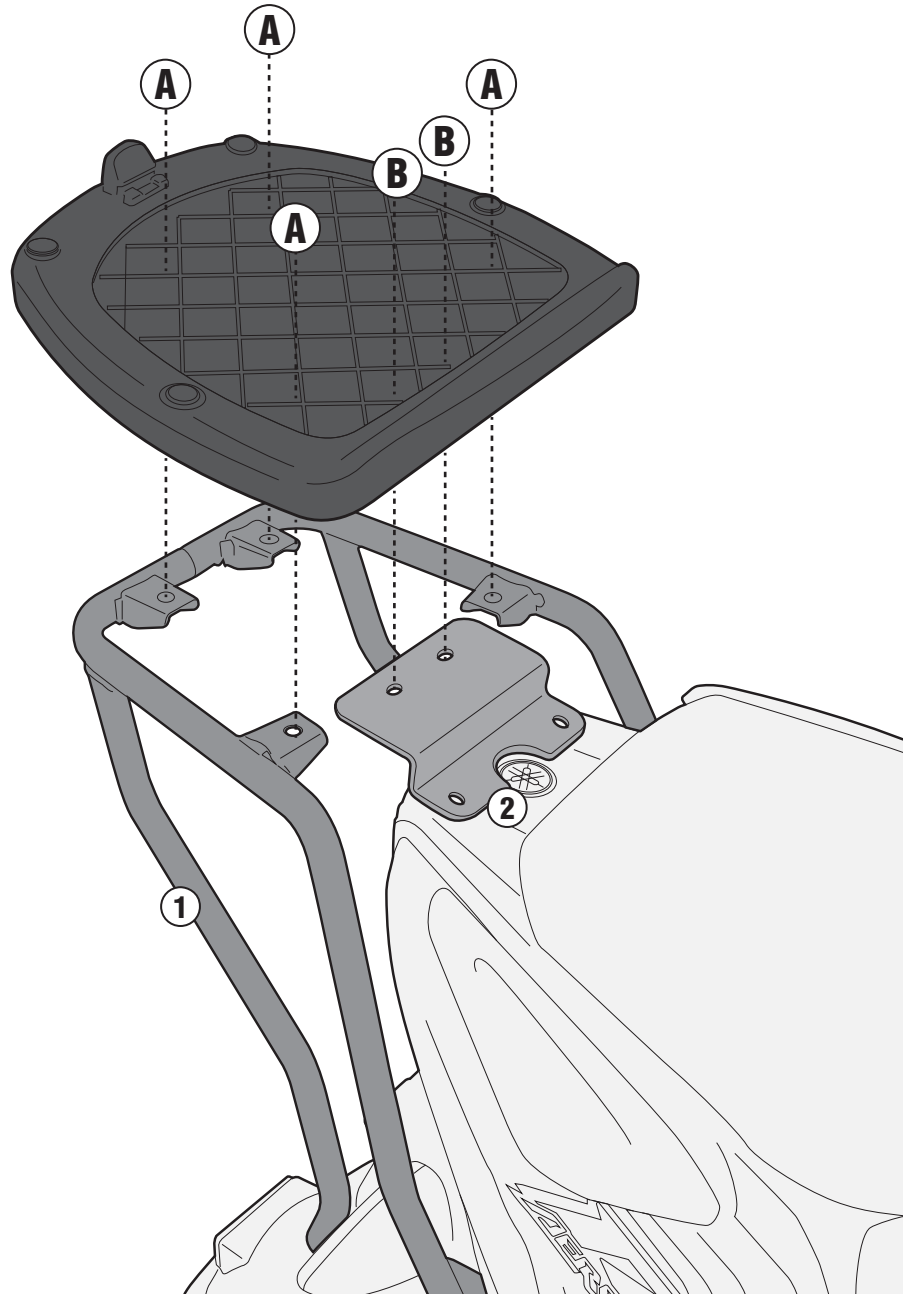
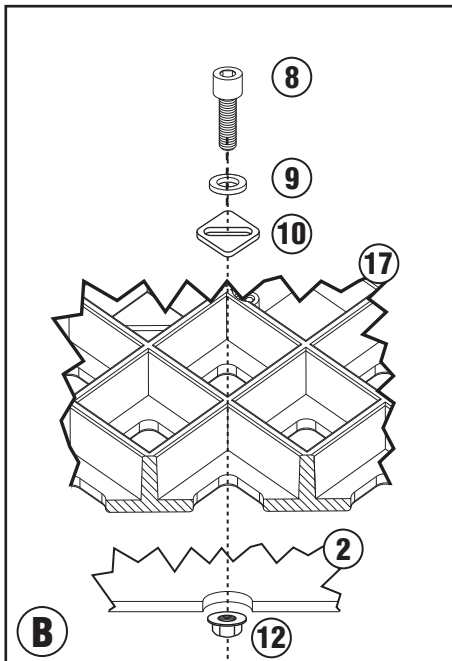
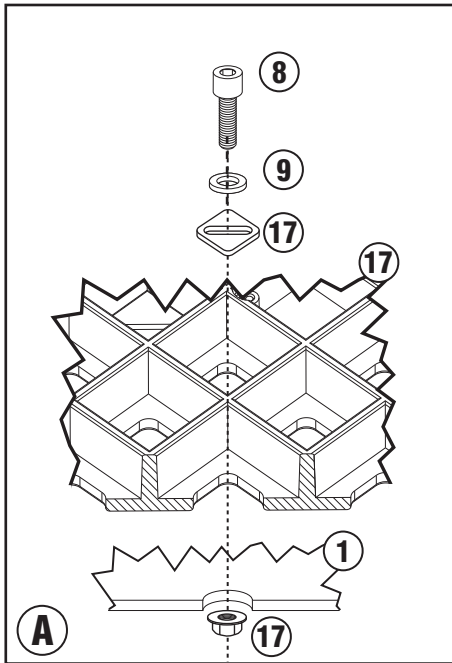
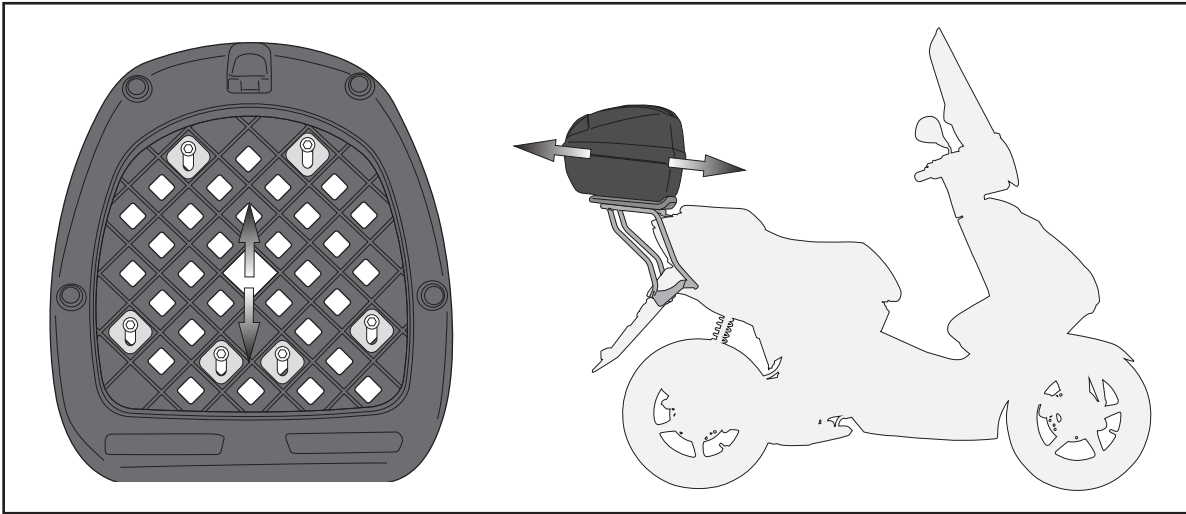

ISTRUZIONI DI MONTAGGIO - MOUNTING INSTRUCTIONS
INSTRUCTIONS DE MONTAGE - BAUANLEITUNG
INSTRUCCIONES DE MONTAJE - INSTRUÇÕES DE MONTAGEM