

PORTAVALIGIA SPECIFICO - SPECIFIC CASE HOLDER
 PORTE-VALISE SPECIFIQUE - SPEZIFISCHER KOFFER-TRÄGER
 PORTA-EQUIPAJE ESPECÍFICO

SUZUKI GLADIUS 2009

650cc

ISTRUZIONI DI MONTAGGIO - MOUNTING INSTRUCTIONS
 INSTRUCTIONS DE MONTAGE - BAUANLEITUNG - INSTRUCCIONES DE MONTAJE

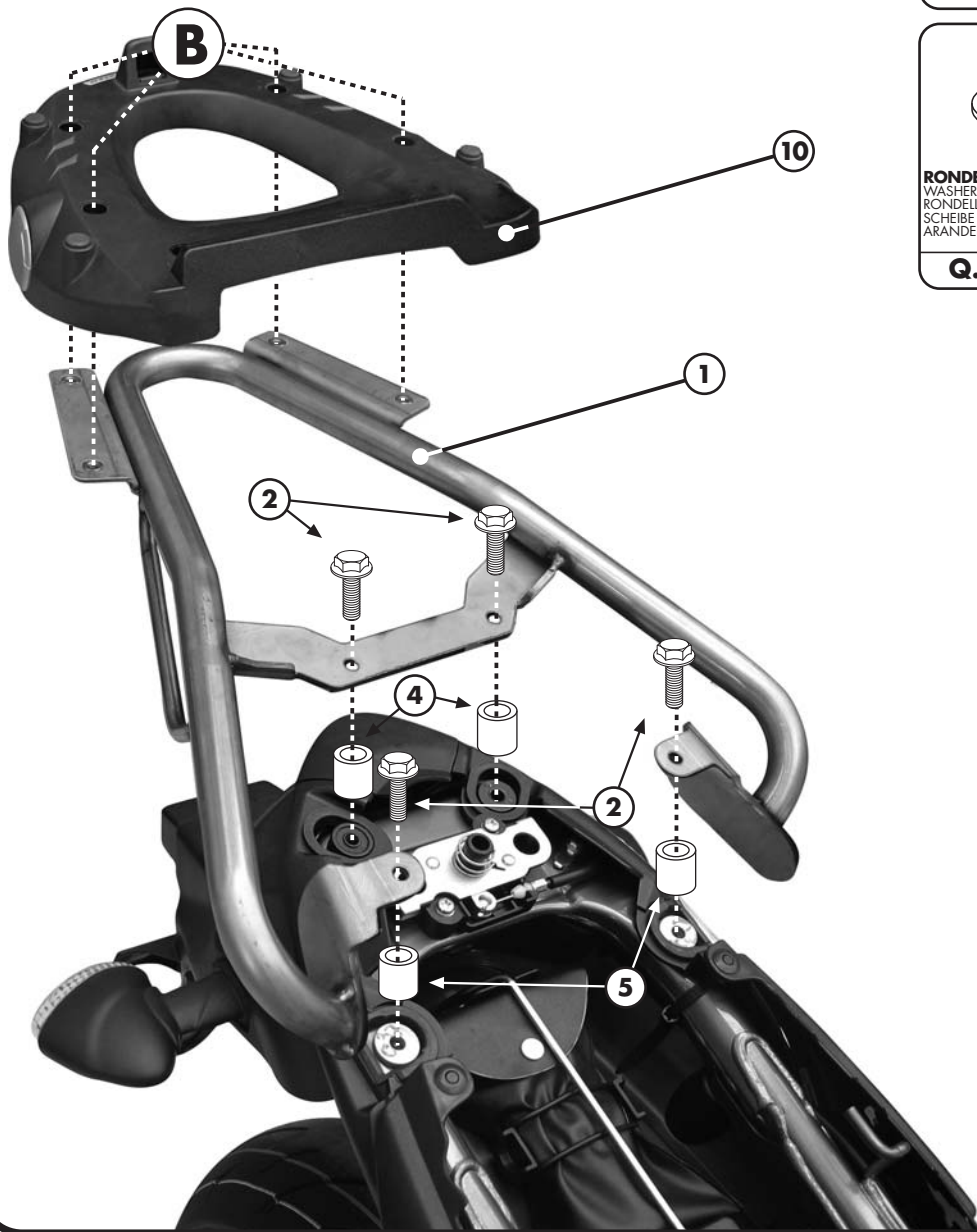

1



SUPPORTO
 SUPPORT
 SUPPORT
 HALTERUNG
 SOPORTE

Q.TY n.1

2



VITE TEF M8x25mm
 SCREW
 VIS
 SCHRAUBE
 TORNILLO

Q.TY n.4

3



VITE TCEI M6x25mm
 SCREW
 VIS
 SCHRAUBE
 TORNILLO

Q.TY n.4

4



DISTANZIALE Ø20x10mm
 SPACER
 Foro Ø8,5mm, V447
 ENTRETOISE
 DISTANZSTUECK
 DISTANCIADOR

Q.TY n.2

5



DISTANZIALE Ø24x5mm
 SPACER
 Foro Ø8,5mm, V037
 ENTRETOISE
 DISTANZSTUECK
 DISTANCIADOR

Q.TY n.2

6



RONDELLA Ø6mm
 WASHER Ø6mm
 RONDELLE Ø6mm
 SCHEIBE Ø6mm
 ARANDELA Ø6mm

Q.TY n.4

7



RONDELLA Ø6x18mm
 WASHER Ø6x18mm
 RONDELLE Ø6x18mm
 SCHEIBE Ø6x18mm
 ARANDELA Ø6x18mm

Q.TY n.4

8



COPRIFORO
 Z621
 BOLT CAP
 CACHE TROU
 STOPSLOCK
 TAPA AGUJERO

Q.TY n.6

9



DADO A.B. M6
 BOLT M6
 ECRON M6
 MUTTER M6
 TUERCA M6

Q.TY n.4

10



PIASTRA MONOLOCK
 PLATE
 PLATINE
 PLATTE
 PARRILLA

Q.TY n.1

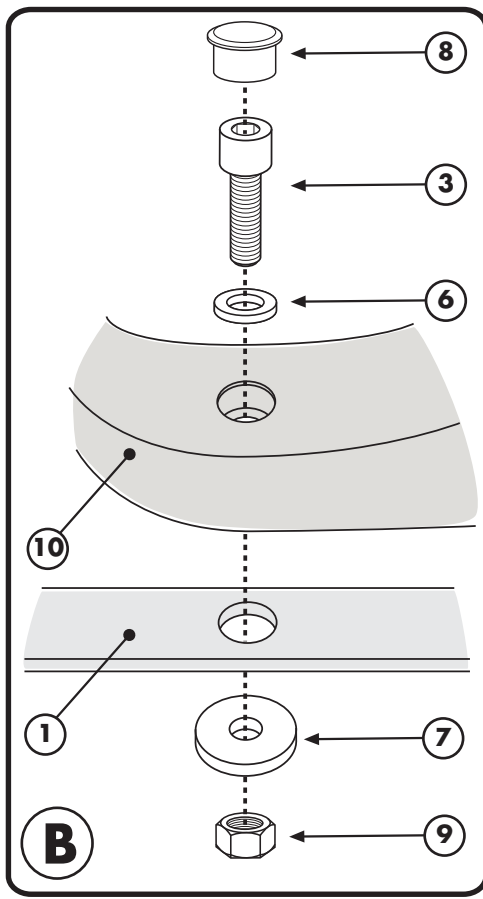

PORTAVALIGIA SPECIFICO - SPECIFIC CASE HOLDER
 PORTE-VALISE SPÉCIFIQUE - SPEZIFISCHER KOFFER-TRÄGER
 PORTA-EQUIPAJE ESPECÍFICO

SUZUKI GLADIUS 2009
650cc

ISTRUZIONI DI MONTAGGIO - MOUNTING INSTRUCTIONS
 INSTRUCTIONS DE MONTAGE - BAUANLEITUNG - INSTRUCCIONES DE MONTAJE

I ISTRUZIONI DI MONTAGGIO

1. RIMUOVERE I MANIGLIONI ORIGINALI E FISSARE IL SUPPORTO N°1 COME MOSTRATO IN FIGURA A;
2. FISSARE LA PIASTRA COME SUGGERITO IN FIGURA B;
3. TERMINARE IL MONTAGGIO ASSICURANDOSI CHE TUTTE LE VITI SIANO BEN SERRATE: VITI M6=9,6Nm - VITI M8=23Nm.

GB MOUNTING INSTRUCTIONS

1. REMOVE THE ORIGINAL HANDLES AND FIX THE SUPPORT N°1 AS YOU CAN SEE FROM PICTURE A;
2. FIX THE PLATE AS YOU CAN SEE FROM PICTURE B;
3. CHECK THAT ALL THE SCREWS ARE WELL TIGHTENED (SCREWS M6=9,6Nm - M8=23Nm).

F INSTRUCTIONS DE MONTAGE

1. ENLVERER LES POIGNEES D'ORIGINE ET FIXER LE SUPPORT N°1 COMME ILLUSTRÉ EN PHOTO A;
2. FIXER LA PLATINE COMME SUGGÈRE EN PHOTO B;
3. TERMINER LE MONTAGE EN CONTROLANT LE BON SERRAGE DE TOUTES LES VIS (VIS M6=9,6Nm - VIS M8=23Nm).

D BAUANLEITUNG

1. ENTFERNEN SIE DIE ORIGINAL HANDGRIFFE UND MONTIEREN SIE DIE HALTERUNG NR. 1 WIE IM BILD A GEZEIGT;
2. MONTIEREN SIE DIE PLATTE WIE IM BILD B GEZEIGT;
3. ZULETZT ÜBERPRÜFEN SIE DAS ALLE SCHRAUBEN (SCHRAUBEN M6=9,6NM - SCHRAUBEN M8=23NM) FESTGEZOGEN WURDEN.

ES INSTRUCCIONES DE MONTAJE

1. QUITAR LOS ASIDEROS ORIGINALES, FIJAR EL SOPORTE N. 1 COMO SE INDICA EN LA FOTO A;
2. FIJAR LA PARRILLA COMO SE SUGIERE EN LA FOTO B;
3. TERMINAR EL MONTAJE VERIFICANDO QUE TODOS LOS TORNILLOS ESTÉN BIEN APRETADOS ((TORNILLOS M6=9,6NM - TORNILLOS M8=23NM).