

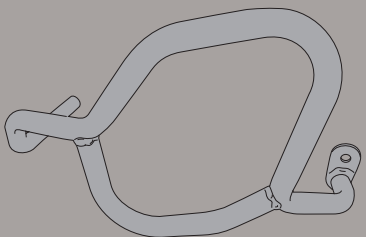







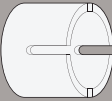
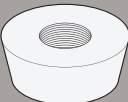

TNH5114 - KNH5114

PARAMOTORE SPECIFICO - SPECIFIC ENGINE GUARD - PARE-CARTER SPECIFIQUE - SPEZIFISCHER STURZBÜGEL - DEFENSA DE MOTOR ESPECÍFICA - PARAMOTOR ESPECÍFICO

BMW R1200GS (2013 - 2014)

N°	Descrizione	Caratteristiche	Codice	Quantità	
1	Paramotore - Engine Guard Pare-carter - Sturzbuegel Defensa De Moto - Paramotor	-	-	2 (Dx;Sx)	
2	Supporto - Support - Support Halterung - Soporte - Apoio	-	-	1	
3	Vite - Screw Vis - Schraube Tornillo - Parafuso	TCEI M10x30 INOX Passo 1,50	1030TCEX	2	
4	Vite - Screw Vis - Schraube Tornillo - Parafuso	TECF M8x20	820TECF	2	
5	Vite - Screw Vis - Schraube Tornillo - Parafuso	TBEI M6x65	670TBEI	2	
6	Fisher - Expanding Tube Insert Cheville - Elastischer Rohreinsatz Taco - Espaçador	Ø33x22 Foro 28mm	LT0979	2	
7	Distanziale - Spacer Entretoise - Distanzstueck Distanciador - Espaçador	Ø29.5/Ø26.5 Foro M10 passo 1,5	V866	2	
8	Rondella - Washer Rondelle - Scheibe Arandela - Arruela	Ø10 INOX	10RONX	2	
9	Rondella - Washer Rondelle - Scheibe Arandela - Arruela	Ø8 Foro 6mm	618RON	4	
10	Dado - Bolt - Erou Mutter - Tuerca - Porca	Dado Auto Bloccante Flangiato Ribassato M6	6DADIABFN	2	
11	Vite - Screw Vis - Schraube Tornillo - Parafuso	TBEI M8x70	870TBEI	2	
12	Rondella - Washer Rondelle - Scheibe Arandela - Arruela	Ø8	805RONX	2	
13	Dado - Bolt - Erou Mutter - Tuerca - Porca	Auto Bloccante Flangiato Ribassato M8	8DADIFN	2	
14	Supporto - Support - Support Halterung - Soporte - Apoio	-	GL2712V	1	

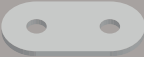
TNH5114 - KNH5114

PARAMOTORE SPECIFICO - SPECIFIC ENGINE GUARD - PARE-CARTER SPECIFIQUE - SPEZIFISCHER STURZBÜGEL - DEFENSA DE MOTOR ESPECÍFICA - PARAMOTOR ESPECÍFICO

BMW

R1200GS

(2013 - 2014)

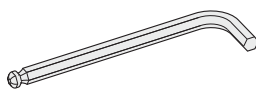
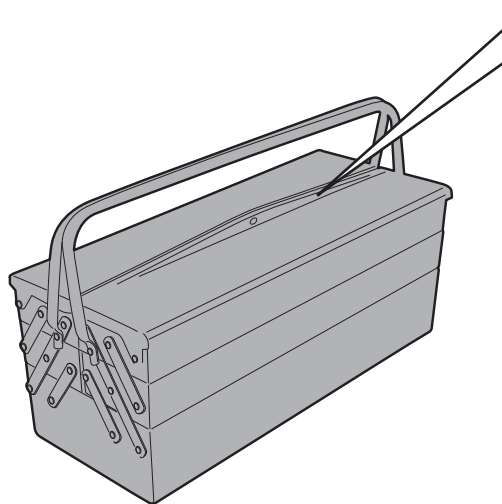
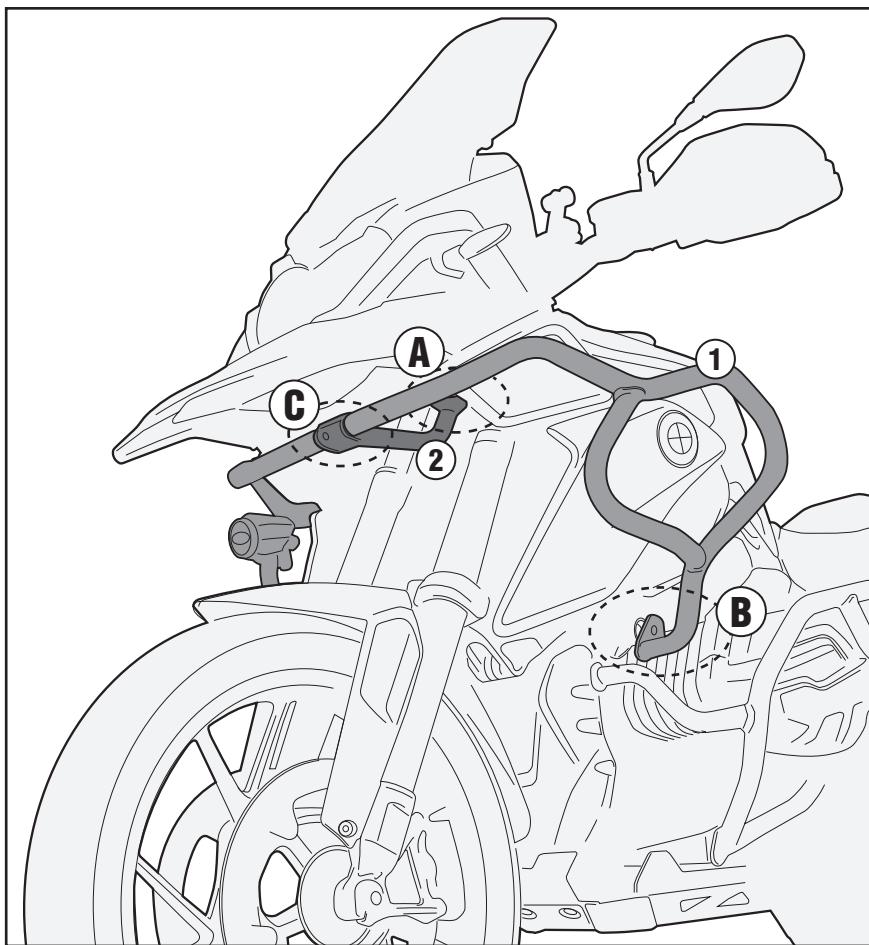

4 mm - 5 mm - 8 mm

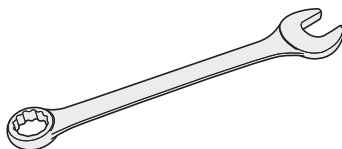

10 mm - 12 mm - 13 mm



TNH5114 - KNH5114

PARAMOTORE SPECIFICO - SPECIFIC ENGINE GUARD - PARE-CARTER SPECIFIQUE - SPEZIFISCHER STURZBÜGEL - DEFENSA DE MOTOR ESPECÍFICA - PARAMOTOR ESPECÍFICO

BMW

R1200GS

(2013 - 2014)

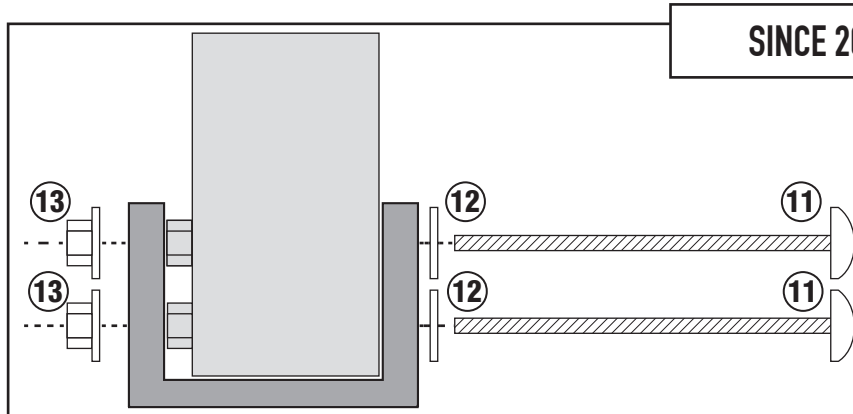
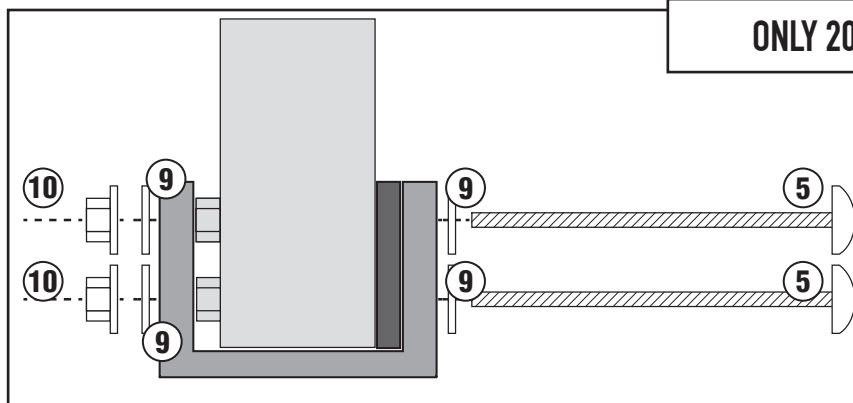
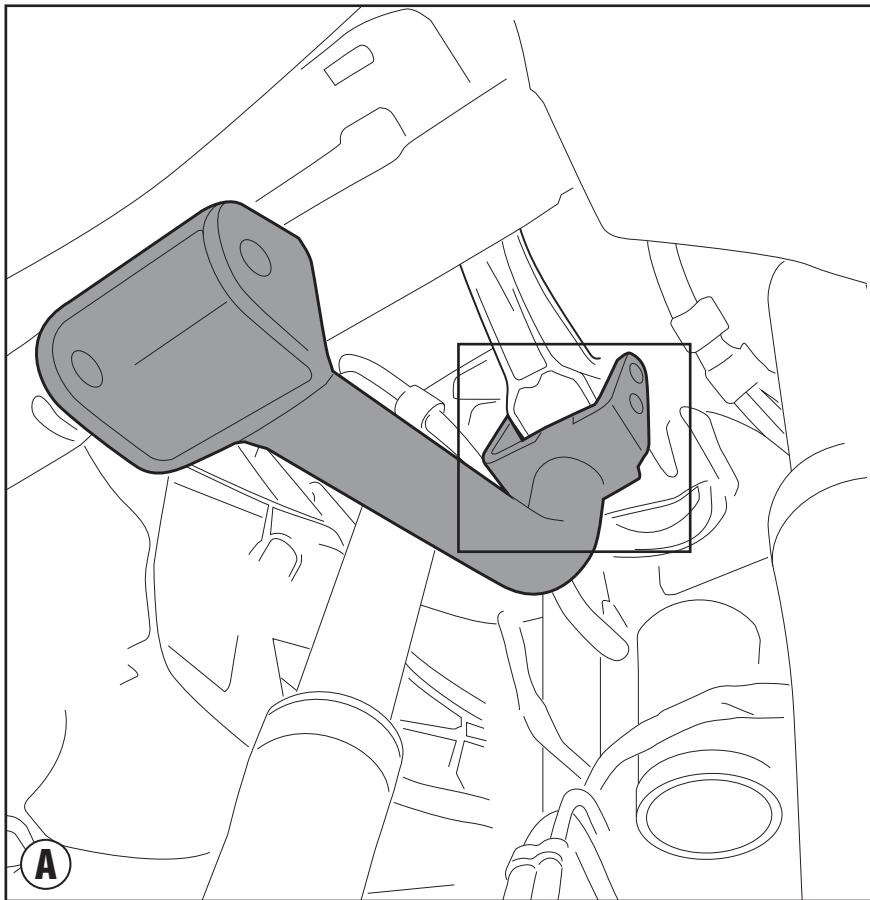

TNH5114 - KNH5114

PARAMOTORE SPECIFICO - SPECIFIC ENGINE GUARD - PARE-CARTER SPECIFIQUE - SPEZIFISCHER STURZBÜGEL - DEFENSA DE MOTOR ESPECÍFICA - PARAMOTOR ESPECÍFICO

BMW

R1200GS

(2013 - 2014)

