

PORTAVALIGIE LATERALE SPECIFICO - SPECIFIC TUBULAR SIDE-CASE HOLDER
 PORTE-VAISES LATÉRAUX SPÉCIFIQUE - SPEZIFISCHES STAHLROHR-SEITENTRÄGER
 PORTA MALETAS LATERALES ESPECIFICO

SUZUKI GLADIUS 2009

650cc

ISTRUZIONI DI MONTAGGIO - MOUNTING INSTRUCTIONS
 INSTRUCCIONES DE MONTAJE - BAUANLEITUNG - INSTRUCCIONES DE MONTAJE

1



SUPPORTO
 SUPPORT
 SUPPORT
 HALTERUNG
 SOPORTE

Q.TY n.2(Dx-Sx)

2



SUPPORTO
 SUPPORT
 SUPPORT
 HALTERUNG
 SOPORTE

Q.TY n.1

3



PIASTRINA
 LITTLE PLATE
 PETITE PLAQUE
 KLEINEMPLATTE
 PLAQUETA

Q.TY n.2

4



PIASTRINA
 LITTLE PLATE
 PETITE PLAQUE
 KLEINEMPLATTE
 PLAQUETA

Q.TY n.1

5



PIASTRINA
 LITTLE PLATE
 PETITE PLAQUE
 KLEINEMPLATTE
 PLAQUETA

Q.TY n.2

6



PIASTRINA
 LITTLE PLATE
 PETITE PLAQUE
 KLEINEMPLATTE
 PLAQUETA

Q.TY n.1

7



PONTE POSTERIORE
 REAR BRIDGE
 PONT POSTÉRIEURE
 VERBINDERSGROH
 PUENTE TRASERO

Q.TY n.1

8



VITE TEF M6x16mm
 SCREW
 VIS
 SCHRAUBE
 TORNILLO

Q.TY n.2

9



VITE TEF M8x50mm
 SCREW
 VIS
 SCHRAUBE
 TORNILLO

Q.TY n.2

10



VITE TEF M6x45mm
 SCREW
 VIS
 SCHRAUBE
 TORNILLO

Q.TY n.2

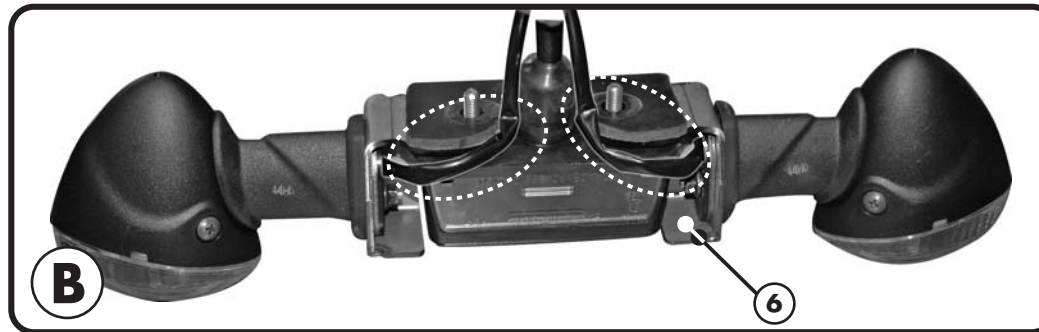
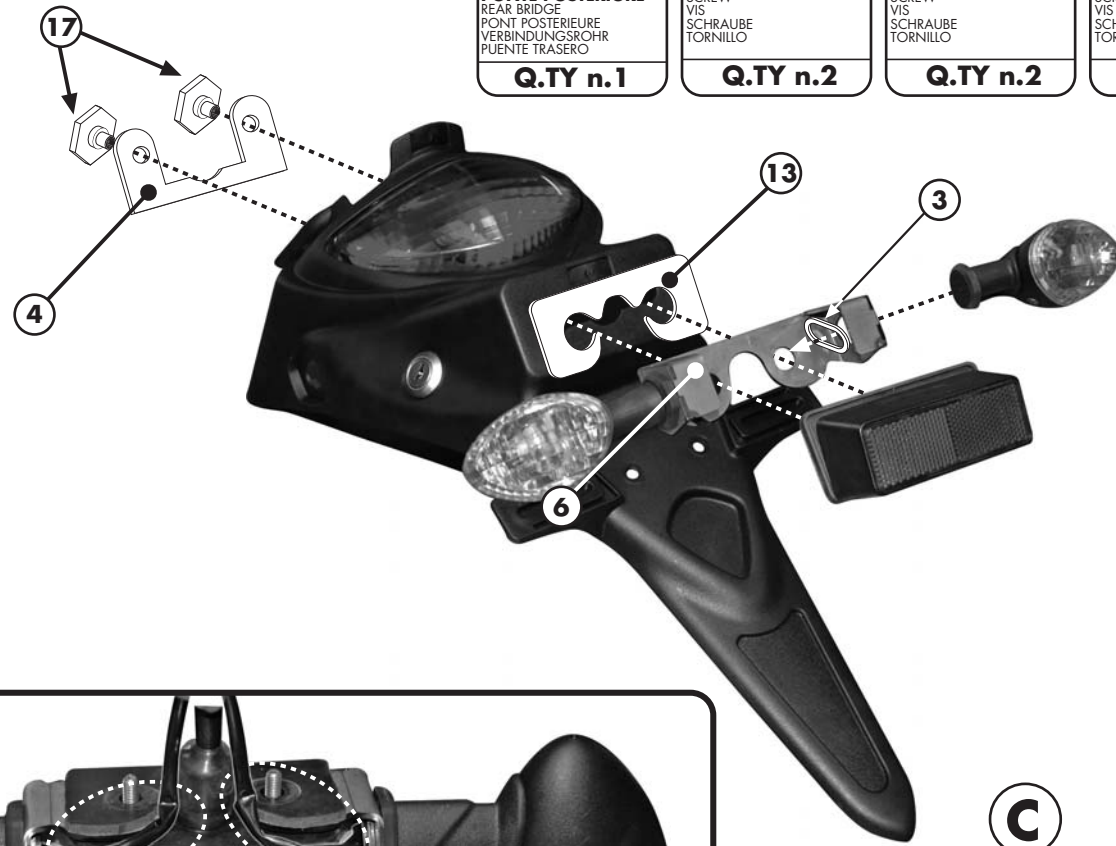
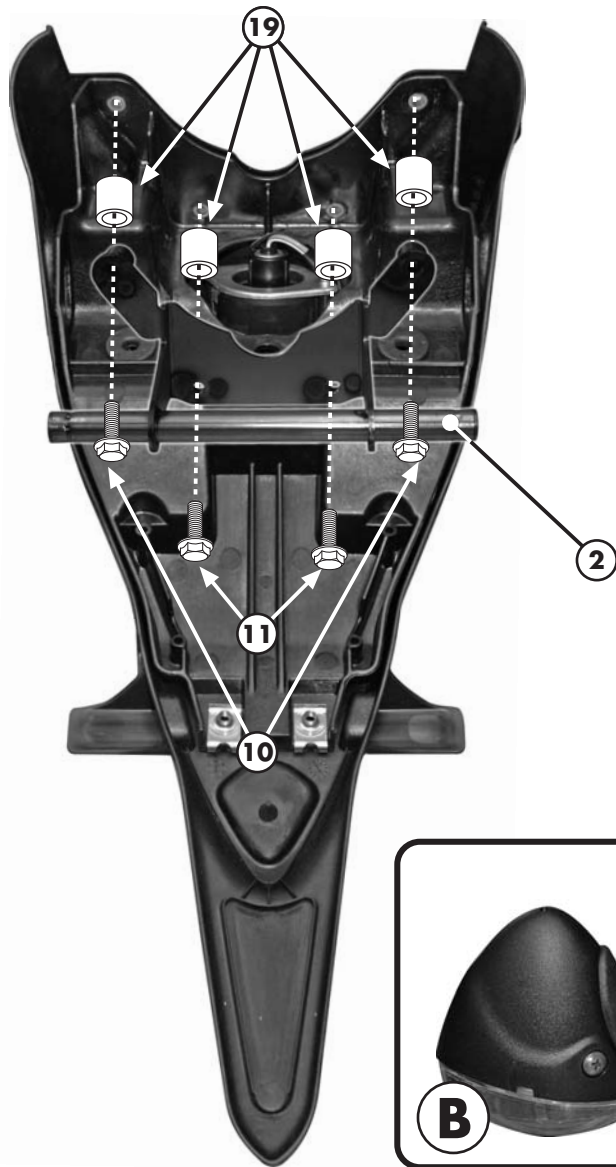

A

B

C

PORTAVALIGIE LATERALE SPECIFICO - SPECIFIC TUBULAR SIDE-CASE HOLDER
 PORTE-VAISES LATÉRAUX SPÉCIFIQUE - SPEZIFISCHES STAHLROHR-SEITENTRÄGER
 PORTA MALETAS LATERALES ESPECÍFICO

SUZUKI GLADIUS 2009

650cc

ISTRUZIONI DI MONTAGGIO - MOUNTING INSTRUCTIONS
 INSTRUCTIONS DE MONTAGE - BAUANLEITUNG - INSTRUCCIONES DE MONTAJE

11



VITE TEF M6x30mm
 SCREW
 VIS
 SCHRAUBE
 TORNILLO

Q.TY n.2

12



VITE TBEI M8x50mm
 SCREW
 VIS
 SCHRAUBE
 TORNILLO

Q.TY n.2

13



GOMMA SAGOMATA
 RUBBER CUSHION
 CAOUTCHOUC PROFILE
 GEFORMTE GUMMI
 GOMA PROTECTORA

Q.TY n.1

14



RONDELLA Ø8mm
 WASHER Ø8mm
 RONDELLE Ø8mm
 SCHEIBE Ø8mm
 ARANDELA Ø8mm

Q.TY n.2

15



DADO A.B. M6
 FLANGIATO
 BOLT M6
 ECROU M6
 MUTTER M6
 TUERCA M6

Q.TY n.2

16



DADO A.B. M8
 FLANGIATO
 BOLT M8
 ECROU M8
 MUTTER M8
 TUERCA M8

Q.TY n.2

17



DADO SPECIALE
 V743
 BOLT
 ECROU
 MUTTER
 TUERCA

Q.TY n.2

18



DADO SPECIALE
 V582
 BOLT
 ECROU
 MUTTER
 TUERCA

Q.TY n.2

19



DISTANZIALE Ø10x7mm
 Foro Ø6 mm, V140
 SPACER
 ENTRETOISE
 DISTANZSTUECK
 DISTANCIADOR

Q.TY n.4

20



DISTANZIALE Ø22x30mm
 Foro Ø8,5mm, V018
 SPACER
 ENTRETOISE
 DISTANZSTUECK
 DISTANCIADOR

Q.TY n.2

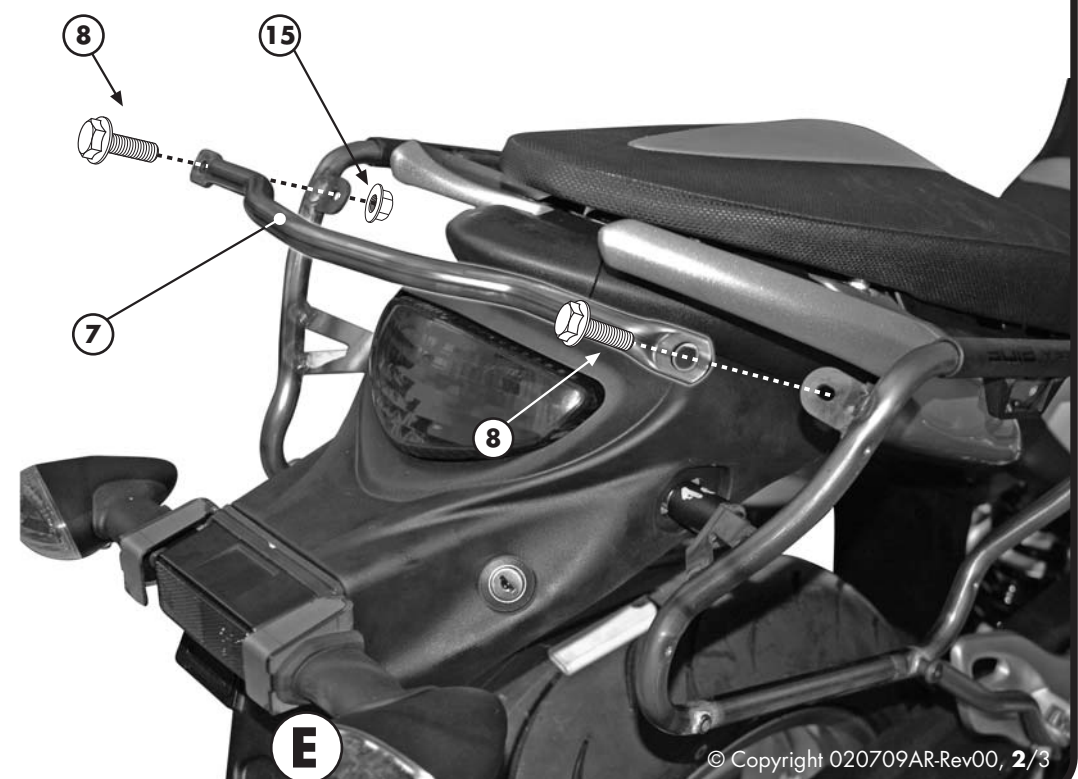
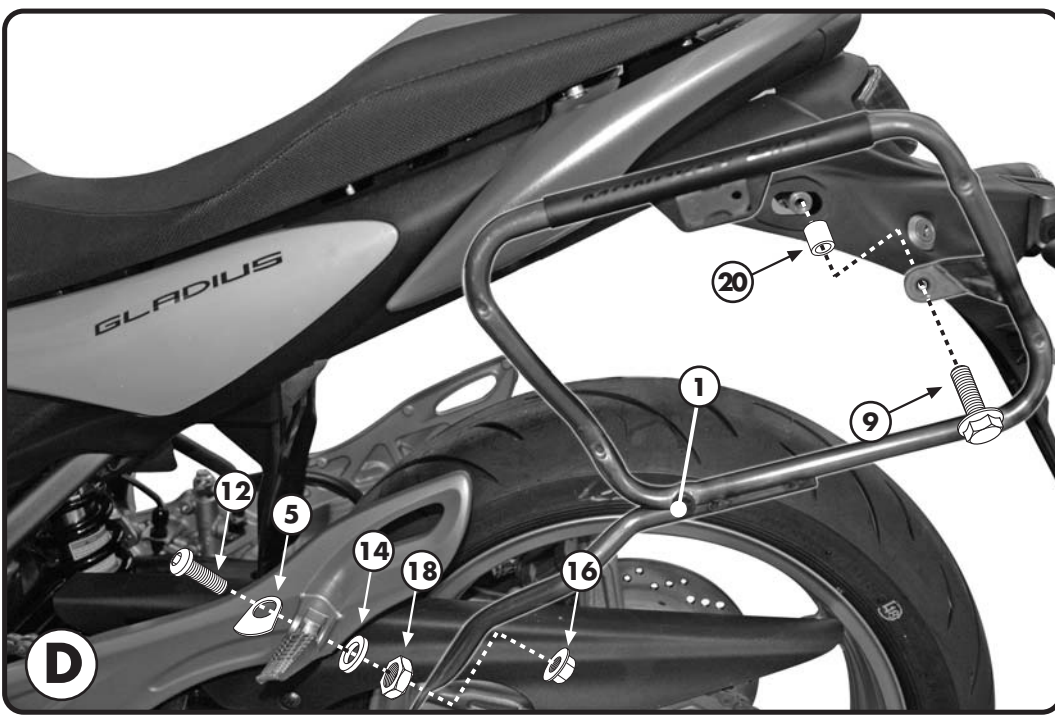

PORTAVALIGIE LATERALE SPECIFICO - SPECIFIC TUBULAR SIDE-CASE HOLDER
 PORTE-VALISES LATÉRAUX SPÉCIFIQUE - SPEZIFISCHES STAHLROHR-SEITENTRÄGER
 PORTA MALETAS LATERALES ESPECÍFICO

SUZUKI GLADIUS 2009

650cc

ISTRUZIONI DI MONTAGGIO - MOUNTING INSTRUCTIONS
 INSTRUCTIONS DE MONTAGE - BAUANLEITUNG - INSTRUCCIONES DE MONTAJE

I ISTRUZIONI DI MONTAGGIO

1. PRIMA DI PROCEDERE AL MONTAGGIO SMONTARE IL PORTATARGA E FISSARE IL SUPPORTO N°2 COME MOSTRATO IN FIGURA A;
2. PRESTARE PARTICOLARE ATTENZIONE AL MONTAGGIO DELLE FRECCHE SUL SUPPORTO N°6: FISSARE LE FRECCHE COME INDICATO IN FIGURA C e ASSICURARSI CHE I CAVI PASSINO SOTTO LA GOMMA SAGOMATA (PARTICOLARE N°13);
3. RIMONTARE IL PORTATARGA COME INDICATO IN FIGURA A;
4. PROCEDERE FISSANDO I SUPPORTI LATERALI ALLE PEDALINE DEL PASSEGGERO E AL SUPPORTO N°2 COME INDICATO IN FIGURA D.
5. ULTIMARE IL MONTAGGIO FISSANDO IL PONTE POSTERIORE COME INDICATO IN FIGURA E;
6. VERIFICARE CHE TUTTE LE VITI SIANO SERRATE BENE (VITI M6=9,6Nm - VITI M8=23Nm).

GB MOUNTING INSTRUCTIONS

1. BEFORE CONTINUING WITH THE MOUNTING, DISASSEMBLE THE SUPPORT FOR THE MOTORCYCLE PLATE AND FIX THE SUPPORT N°2 AS YOU CAN SEE FROM PICTURE A;
2. PAY GREAT ATTENTION TO THE REAR LIGHT MOUNTING ON THE SUPPORT N°6; FIX THE REAR LIGHTS AS YOU CAN SEE FROM PICTURE C AND MAKE SURE THAT THE CABLES PASS UNDER THE TEMPLATED RUBBER (DETAIL N°13);
3. SET AGAIN THE SUPPORT FOR THE MOTORCYCLE PLATE AS YOU CAN SEE FROM PICTURE A;
4. GO ON FIXING THE SIDE SUPPORT TO THE PASSENGER FOOT RESTS AND TO THE SUPPORT N°2 AS YOU CAN SEE FROM PICTURE D;
5. FINISH THE MOUNTING FIXING THE BACK BRIDGE AS YOU CAN SEE FROM PICTURE E;
6. CHECK THAT ALL THE SCREWS ARE WELL TIGHTENED (SCREWS M6=9,6Nm - SCREWS M8=23Nm).

F INSTRUCTIONS DE MONTAGE

1. AVANT DE PROCEDER AU MONTAGE, DEMONTER LE SUPPORT DEPLAQUE ET FIXER LE SUPPORT N°2 COMME ILLUSTRÉ EN PHOTO A;
2. FAIRE TRES ATTENTION AU MONTAGE DES CLIGNOTANTS SUR LE SUPPORT N°6; FIXER LES CLIGNOTANTS COMME INDIQUE EN PHOTO C ET S'ASSURER QUE LES CABLES PASSENT SOUS LA PLAQUE FACONNEE (PIECE N°13);
3. REMONTER LE SUPPORT DE PLAQUE COMME INDIQUÉ EN PHOTO A;
4. POURSUIVRE EN FIXANT LES SUPPORTS LATÉRAUX AUX REPOSE-PIEDS PASSAGER ET AU SUPPORT N°2 COMME INDIQUE EN PHOTO D;
5. TERMINER LE MONTAGE EN FIXANT LE PONT POSTERIEUR COMME INDIQUE EN PHOTO E;
6. VERIFIER QUE TOUTES LES VIS SOIENT BIEN SERREES (VIS M6=9,6Nm - VIS M8=23Nm).

D BAUANLEITUNG

1. VOR MONTAGE DES TRÄGERS, DEMONTIEREN SIE ZUERST DEN HALTER FÜR DAS KENNZEICHEN UND BEFESTIGEN SIE DANN DIE HALTERUNG NR. 2 WIE IM BILD A GEZEIGT.
2. BEACHTEN SIE BITTE DIE MONTAGE DER BLINKER AUF DER HALTERUNG NR. 6; MONTIEREN SIE DIE BLINKER WIE IM BILD C GEZEIGT UND PRÜFEN SIE DASS DIE KABEL UNTER DIE GEFORMTEN GUMMI (POSITION NR. 13) PASSEN;
3. MONTIEREN SIE DEN KENNZEICHENHALTER WIE IM BILD A GEZEIGT;
4. MONTIEREN SIE DIE SEITENHALTERUNGEN AN DEN BEIFÄHRER-FUSSRASTERN UND AN DER HALTERUNG NR. 2 WIE IM BILD D GEZEIGT;
5. MONTIEREN SIE ZULETZT DIE HINTERE BRÜCKE WIE IM BILD E GEZEIGT;
6. ABSCHLIEßEND ÜBERPRÜFEN SIE DASS ALLE SCHRAUBEN (SCHRAUBEN M6=9,6NM - SCHRAUBEN M8=23NM) FESTGEZOGEN WURDEN.

ES INSTRUCCIONES DE MONTAJE

1. ANTES DE PROCEDER AL MONTAJE, DESMONTAR EL PORTA MATRICULA Y FIJAR EL SOPORTE N.2 COMO SE INDICA EN LA FOTO A;
2. PRESTAR ATENCIÓN AL MONTAJE DE LOS INTERMITENTES SOBRE EL SOPORTE N.6: FIJAR LOS INTERMITENTES COMO SE INDICA EN LA FOTO C Y ASEGURARSE QUE LOS CABLES PASEN BAJO DE LA GOMA (REFERENCIA N13);
3. VOLVER A MONTAR EL PORTA MATRICULA COMO SE INDICA EN LA FOTO A;
4. PROCEDER A LA FIJACIÓN DE LOS SOPORTES LATERALES A LOS ESTRIBOS DEL PASAJERO Y AL SOPORTE N.2 COMO SE INDICA EN LA FOTO D
5. COMPLETAR EL MONTAJE FIJANDO EL PUENTE POSTERIOR COMO SE INDICA EN LA FOTO E;
6. VERIFICAR QUE TODOS LOS TORNILLOS ESTÉN BIEN APRETADOS (TORNILLOS M6=9,6NM - TORNILLOS M8=23NM).