

PORTAVALIGIE LATERALE SPECIFICO - SPECIFIC TUBULAR SIDE-CASE HOLDER
 PORTE-VAISES LATÉRAUX SPÉCIFIQUE - SPEZIFISCHES STAHLROHR-SEITENTRÄGER
 PORTA MALETAS LATERALES ESPECÍFICO

TRIUMPH 2011 TIGER 800 - TIGER 800 XC

ISTRUZIONI DI MONTAGGIO - MOUNTING INSTRUCTIONS
 INSTRUCCIONES DE MONTAJE - BAUANLEITUNG - INSTRUCCIONES DE MONTAJE

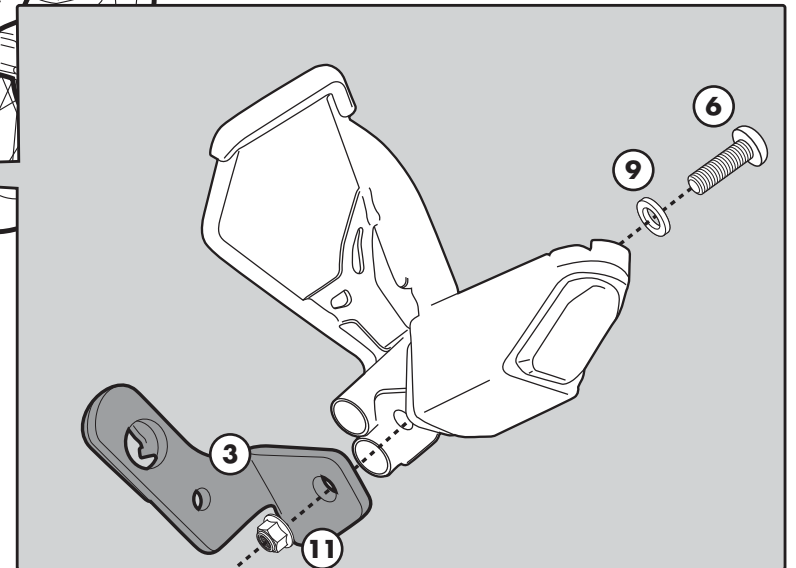
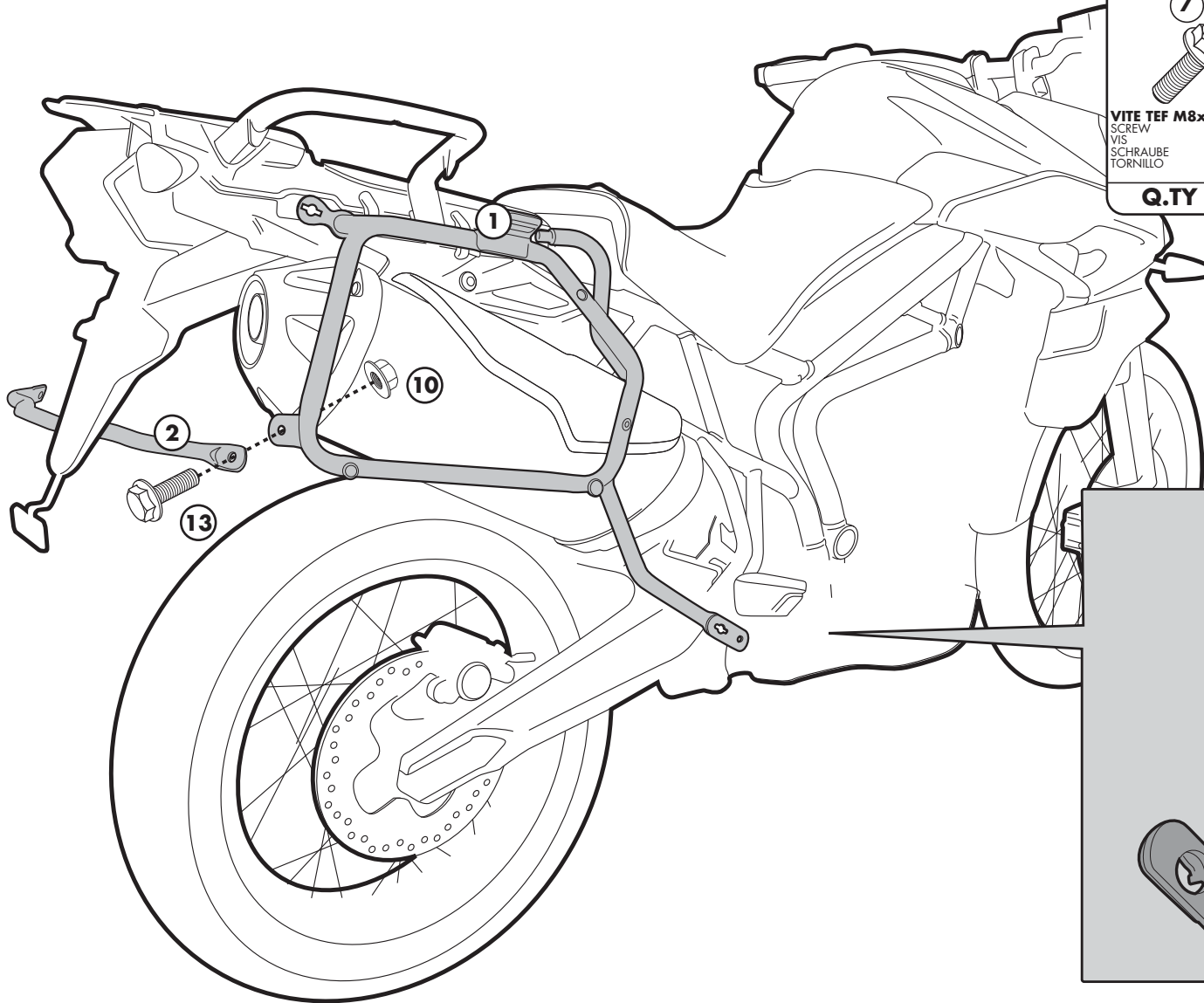
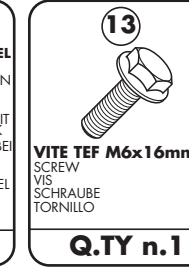
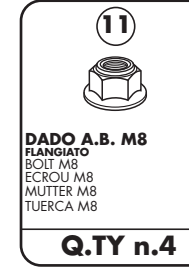
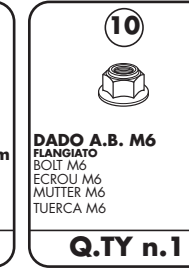
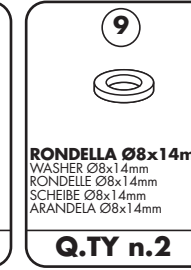
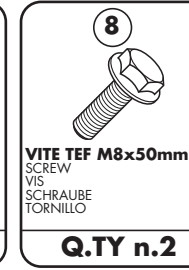
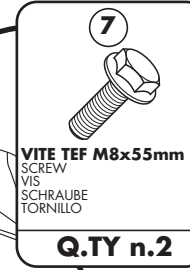
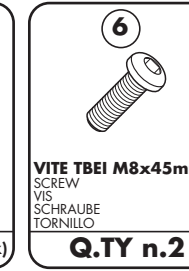
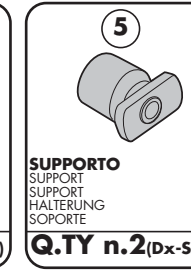
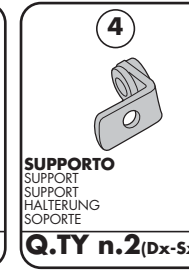
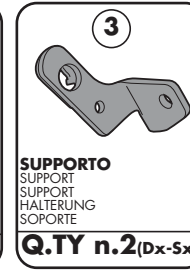
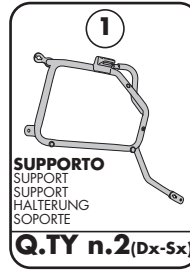

PORTAVALIGIE LATERALE SPECIFICO - SPECIFIC TUBULAR SIDE-CASE HOLDER
 PORTE-VALISES LATÉRAUX SPÉCIFIQUE - SPEZIFISCHES STAHLROHR-SEITENTRÄGER
 PORTA MALETAS LATERALES ESPECÍFICO

TRIUMPH 2011 TIGER 800 - TIGER 800 XC

ISTRUZIONI DI MONTAGGIO - MOUNTING INSTRUCTIONS
 INSTRUCCIONES DE MONTAJE - BAUANLEITUNG - INSTRUCCIONES DE MONTAJE

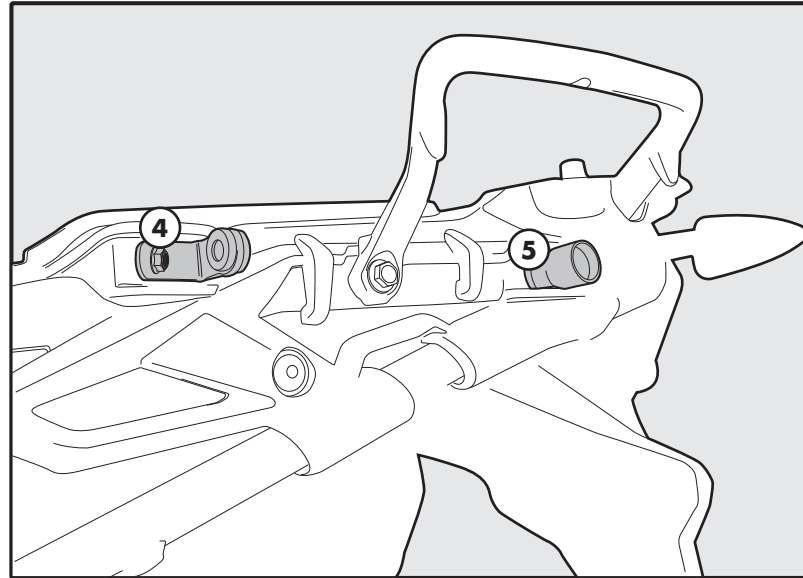

SR SPECIFICO+PORTAVALIGIE LATERALE SPECIFICO
 SPECIAL RACK+SPECIFIC TUBULAR SIDE-CASE HOLDER
 SPECIAL RACK+PORTE-VALISES LATÉRAUX SPÉCIFIQUE
 SPECIAL RACK+SPEZIFISCHES STAHLROHR-SEITENTRÄGER
 SPECIAL RACK+PORTA-MALETAS LATERAL ESPECÍFICO

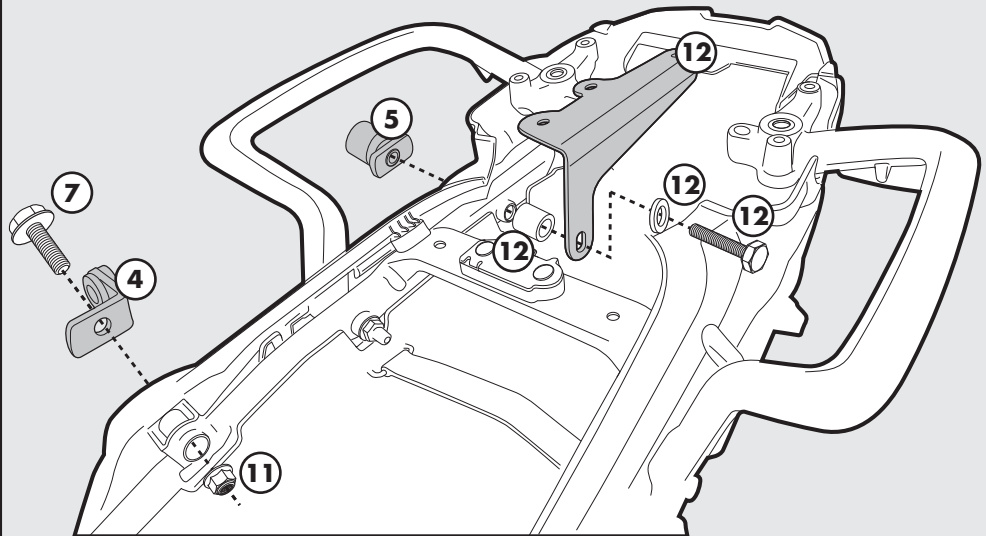

SOLO PORTAVALIGIE LATERALE SPECIFICO
 ONLY SPECIFIC TUBULAR SIDE-CASE HOLDER
 SEUL PORTE-VALISES LATÉRAUX SPÉCIFIQUE
 NUR SPEZIFISCHES STAHLROHR-SEITENTRÄGER
 SOLO PORTA-MALETAS LATERAL ESPECÍFICO

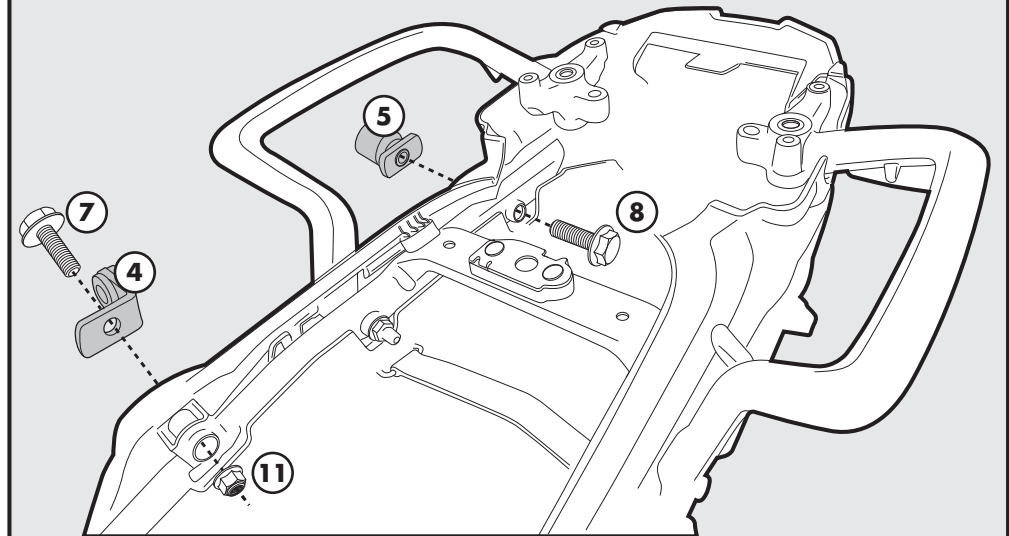

MONTAGGIO / SMONTAGGIO PORTAVALIGE LATERALE VERSIONE PLR "RAPID"



I

1. INSERIRE L'ATTREZZO NELLA TESTA DELLA VITE SPECIALE;
2. RUOTARE DI 1/4 DI GIRO IN SENSO ORARIO FINO A CHE LA ROTAZIONE NON TERMINA E SI AVVERTE LO SCATTO;
3. PER SMONTARE PROCEDERE IN SENSNO INVERSO.

GB

1. INSERT THE SPECIAL KEY INTO THE HEAD OF THE SCREW;
2. TURN THE KEY ¼ TURN CLOCKWISE UNTIL ROTATION STOPS AND THE SIDE CASE HOLDER IS FASTENED SECURELY TO THE FITMENT POINT;
3. IN ORDER TO DISASSEMBLE THE BRACKETRY PERFORM THE OPERATION IN REVERSE.

F

1. INSERER LA CLE SPECIALE DANS LA TETE DE LA VIS;
2. VISSER D'1/4 DE TOUR DANS LE SENS HORAIRE JUSQU'AU BLOCAGE DE LA VIS POUR MONTER EN TOUTE SECURITE LE SUPPORT A SON POINT DE FIXATION;
3. POUR LE DEMONTAGE, PROCEDER EN SENSE INVERSE.

D

1. STECKEN SIE DAS WERKZEUG IN DEN KOPF DER SPEZIFISCHEN SCHRAUBE;
2. DREHEN SIE DIE SCHRAUBE 1 / 4 UMDREHUNG IM UHRZEIGERSINN BIS SIE BEMERKEN, DASS DIE SCHRAUBE IM BEFESTIGUNGSPUNKT EINGEKLEMMT IST;
3. FÜR DIE DEMONTAGE FOLGEN SIE DEN HINWEISE UMGEKEHRT.

ES

1. INSERTAR LA LLAVE ESPECIAL EN LA CABEZA DEL TORNILLO
2. DAR ¼ DE VUELTA EN EL SENTIDO HORARIO HASTA QUE LLEGUE AL TOPE Y SE VEA EL TORNILLO;
3. PARA DESMONTARLO PROCEDER EN LA DIRECCIÓN CONTRARIA;



FORO DI SICUREZZA

FORO PREDISPOSTO AD ASSICURARE IL PORTAVALIGE LATERALE ALLA MOTO (CON UN LUCCHETTO PER ESEMPIO, NON INCLUSO).

TROU DE SECURITE

TROU PREDISPOSE POUR ASSURER LE PORTE-VALISE LATERAL A LA MOTO (AVEC UN CADENAS PAR EXEMPLE, NON INCLUS).

TROU DE SECURITE

TROU PREDISPOSE POUR ASSURER LE PORTE-VALISE LATERAL A LA MOTO (AVEC UN CADENAS PAR EXEMPLE, NON INCLUS).

FORO DI SICUREZZA

VORGESEHENES LOCH UM DEN SEITENKOFFER TRÄGER AN DEM FAHRZEUG ZU SICHERN (Z. B. MIT EINEM VORHÄNGESCHLOSS, NICHT ENTHALTEN);

ORIFICIO DE SEGURIDAD

ESTE ORIFICIO ESTA CREADO PARA ASEGURAR EL PORTAEQUIPAJES LATERAL A LA MOTO (POREJEMPLO CON UN CANDADO, QUE NO ESTÁ INCLUIDO).

