

A7054A- A7054A

ATTACCHI SPECIFICI PER - SPECIFIC FITTING KIT FOR - KIT DE MONTAGE SPECIFIQUE POUR - SPEZIFISCHER MONTAGEKIT FÜR - ANCLAJE ESPECÍFICO PARA

SYM SIMPHONY 50-125-200 (2015)

N°	Descrizione	Caratteristiche	Codice	Quantità
1	Supporto - Support - Support Halierung - Soporte	-	A7054DXS A7054SXS	2 (Dx,Sx)
2	Vite - Screw Vis - Schraube Tornillo	TBEI M6x25	625TBEI	6
3	Vite - Screw Vis - Schraube Tornillo	TCEI M8x50	850TCE	2
4	Dado - Bolt - Ecrou Mutter - Tuerca	Auto Bloccante Ribassato M6	6DADIB	2
5	Rondella - Washer Rondelle - Scheibe Arandela	Ø6	6RON	2
6	Supporto - Support - Support Halierung - Soporte	-	Z4861	4
7	Rondella - Washer Rondelle - Scheibe Arandela	-	814RON	2
8	Boccola Di Ritenzione - Plastic Bush Douille Plastique - Plastik Buchse Casquillo	-	Z4862	4
9	Gommino - Fairleader Chaumard - Gummi Goma	-	Z4860	4
10	Fascetta - Clamp - Collier - Schelle - Abrazadera	-	Z805	2
11	MOUSSE	-	Z1072	2
12	Componenti Originali - Original Parts Parties Originales - Original Bauteile Componentes Originales - Componentes Originais	-	-	-

A7054A- A7054A

ATTACCHI SPECIFICI PER - SPECIFIC FITTING KIT FOR - KIT DE MONTAGE SPECIFIQUE POUR - SPEZIFISCHER MONTAGEKIT FÜR - ANCLAJE ESPECÍFICO PARA

SYM SIMPHONY 50-125-200 (2015)

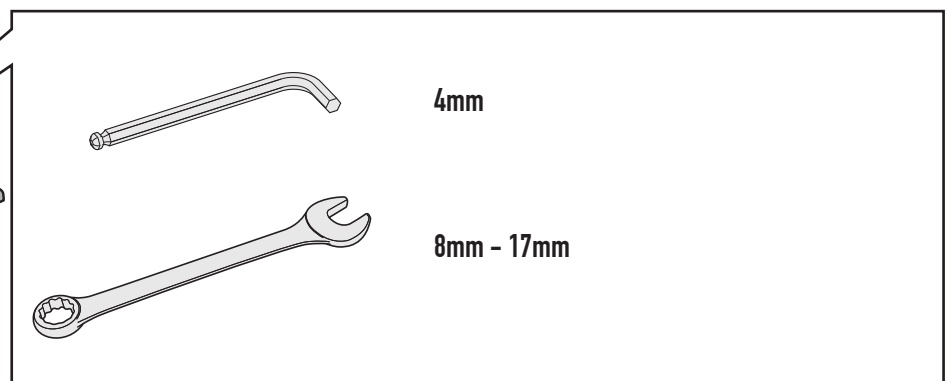
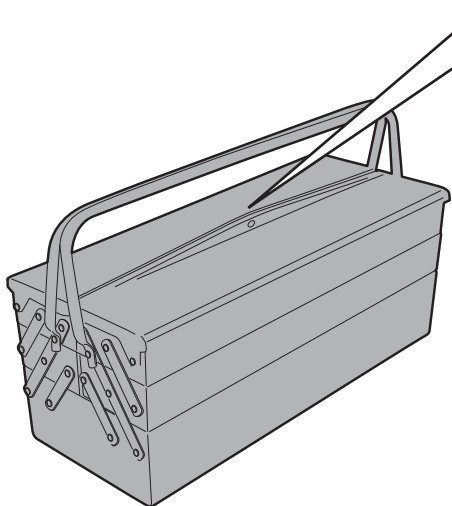
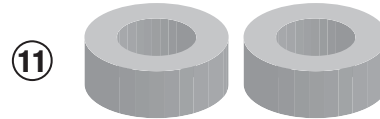
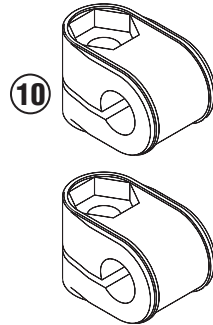
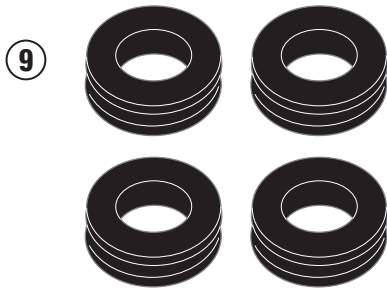
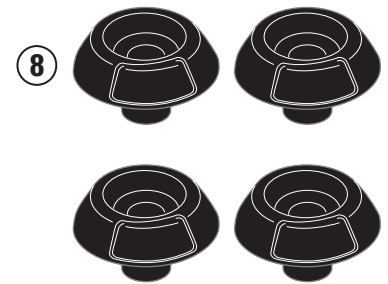
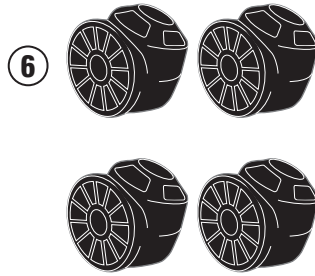
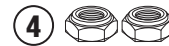
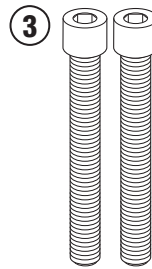
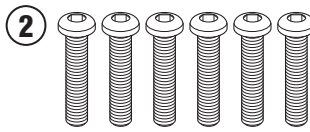
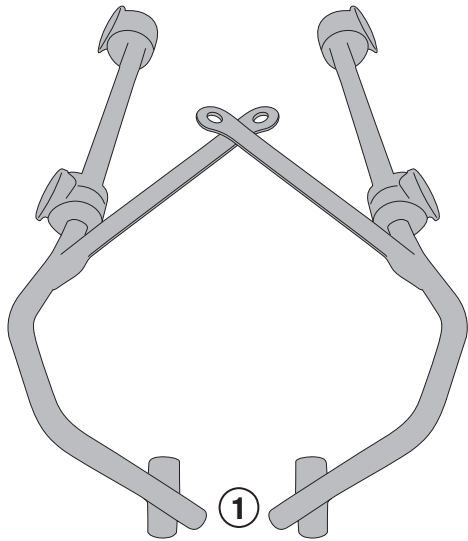

A7054A- A7054A

ATTACCHI SPECIFICI PER - SPECIFIC FITTING KIT FOR - KIT DE MONTAGE SPECIFIQUE POUR - SPEZIFISCHER MONTAGEKIT FÜR - ANCLAJE ESPECÍFICO PARA

SYM SIMPHONY 50-125-200 (2015)

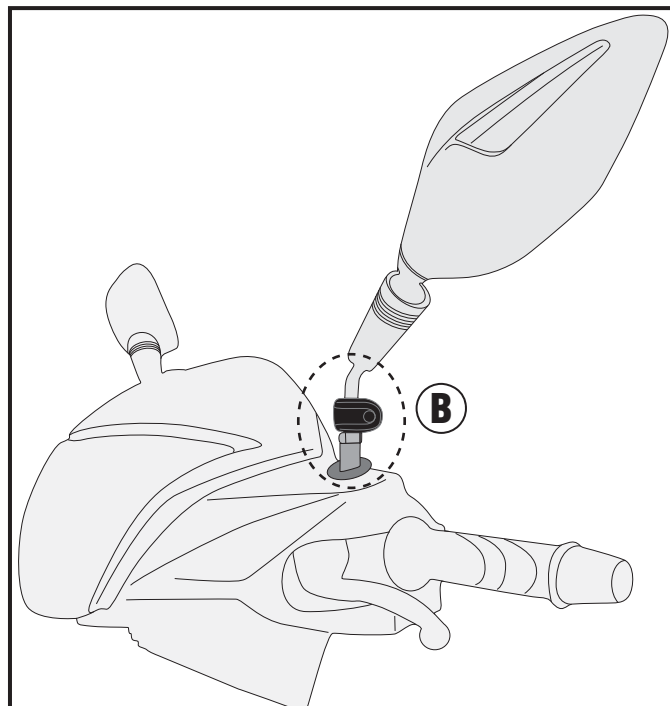
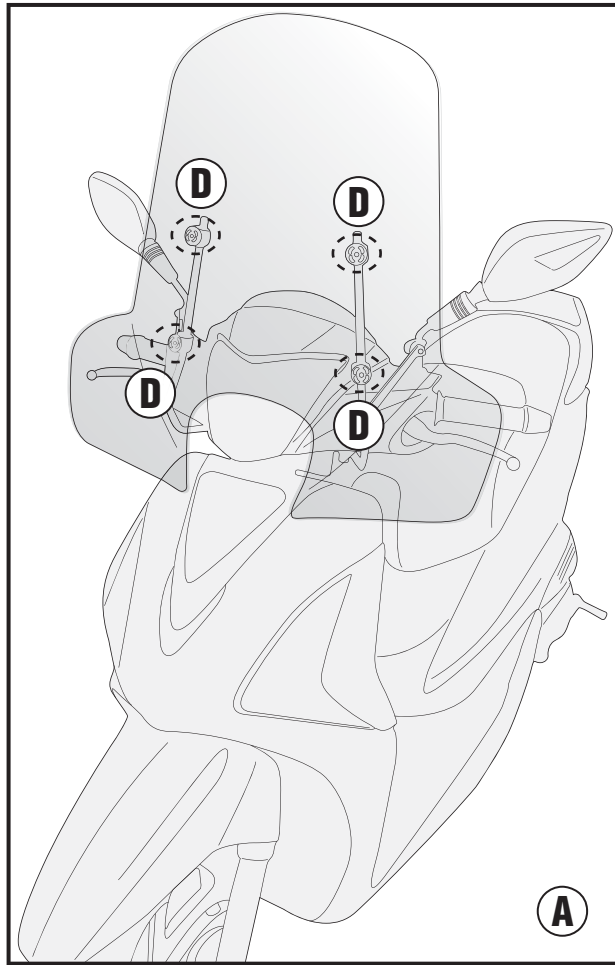

A7054A- A7054A

ATTACCHI SPECIFICI PER - SPECIFIC FITTING KIT FOR - KIT DE MONTAGE SPECIFIQUE POUR - SPEZIFISCHER MONTAGEKIT FÜR - ANCLAJE ESPECÍFICO PARA

SYM SIMPHONY 50-125-200 (2015)

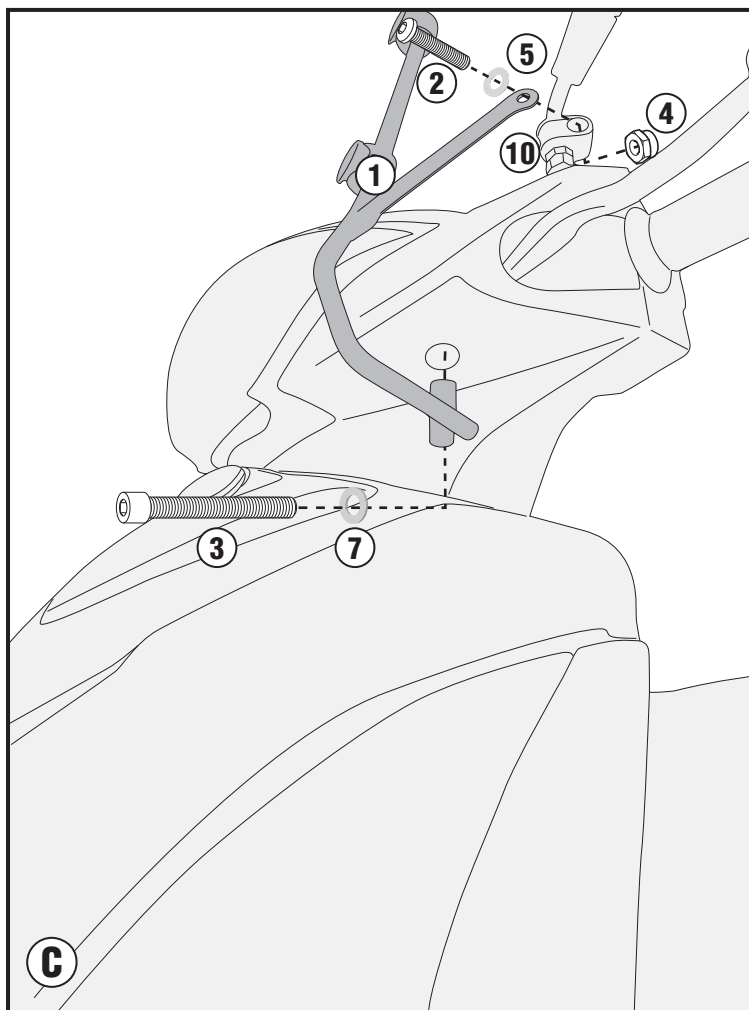
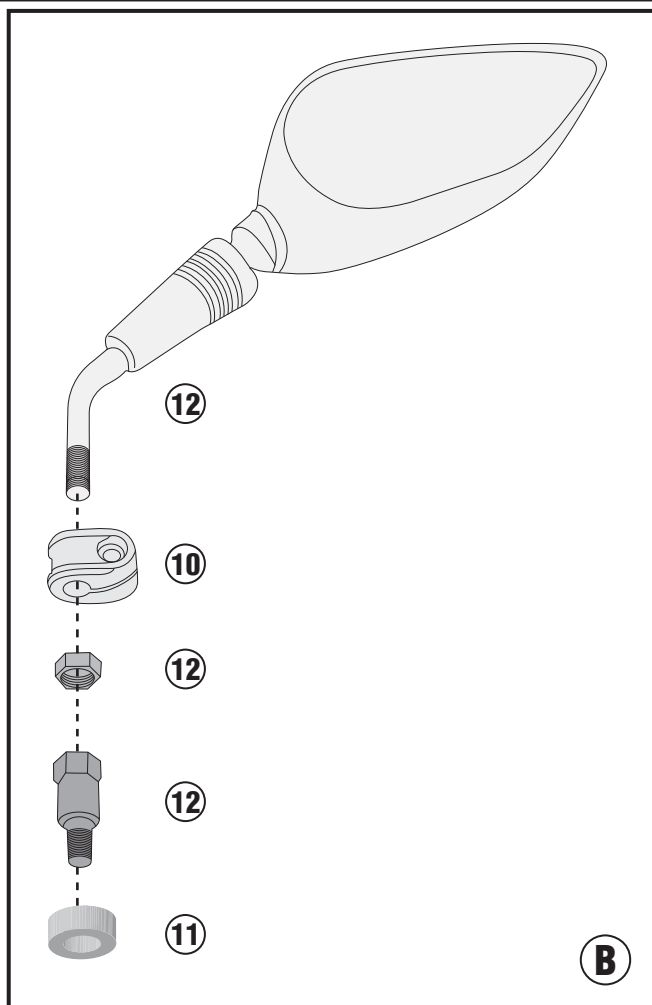

A7054A- A7054A

ATTACCHI SPECIFICI PER - SPECIFIC FITTING KIT FOR - KIT DE MONTAGE SPECIFIQUE POUR - SPEZIFISCHER MONTAGEKIT FÜR - ANCLAJE ESPECÍFICO PARA

SYM SIMPHONY 50-125-200 (2015)

